

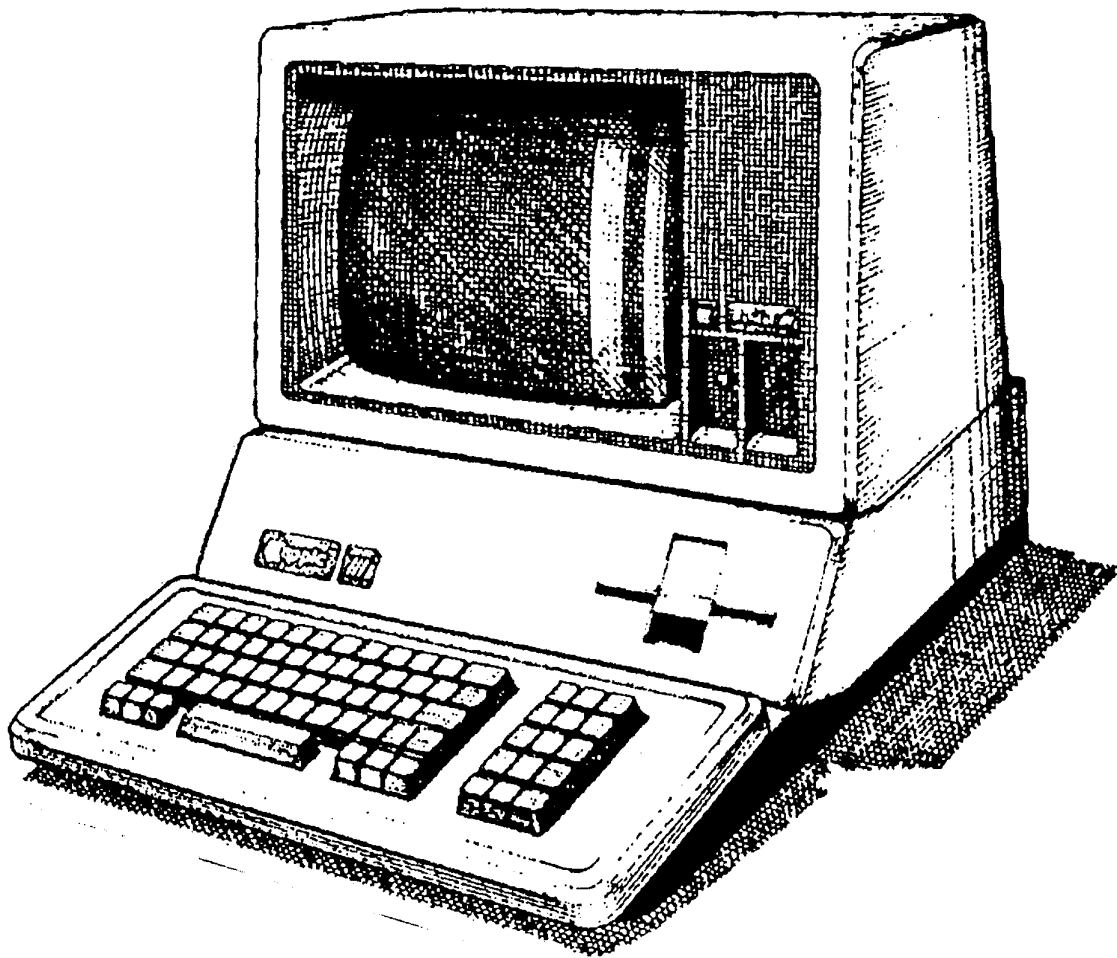

## Apple III Computer Information



DOCUMENT NAME		#
<i>Repair Info: Monitor III</i>	<i>Apple Oct. 1988</i>	<i>224</i>

**Ex Libris David T. Craig**

 **Apple Technical Procedures**

# Monitor III

## Section 1 – Monitor III Exchange

---

### CONTENTS

1.3	Introduction
1.3	Safety Precautions
1.6	Exchange Procedure
1.6	Rear Cover Removal
1.8	Rear Cover Installation

©Apple Computer, Inc., 1988. No portion of this document may be reproduced in any form without the written permission of Apple Computer, Inc.

Apple and the Apple logo are registered trademarks of Apple Computer, Inc.

P. 1.2 blank

## □ INTRODUCTION

When a customer brings in a defective Monitor III, do not attempt any repair or adjustment procedure. Take a new Monitor III from your service stock and remove the rear cover. Next, remove the rear cover of the failed Monitor III, replace it with the non-serialized rear cover (shipping fixture) from the service stock unit, and return the failed Monitor III to Apple for exchange. Then, install the rear cover from the customer's Monitor III on the back of the service stock unit, and give the service stock Monitor III to the customer.

If you do not have a Monitor III in your service stock, follow the Advanced Exchange procedures described in the *Service Programs Manual* to obtain a replacement monitor (either a Monitor II or a Monitor III) from Apple.

**Note:** The Monitor II should not be used to replace a Monitor III if the customer is using an Apple III computer with the video interlace mode enabled. Differences in the type of phosphors used in the two monitors result in flickering of screen text and graphics when the Monitor II is used with an Apple III computer in video interlace mode.

### Safety Precautions

Whenever you remove the rear cover of the Monitor III, you are exposed to the high-voltage Cathode-Ray Tube (CRT)—the picture tube. Because the Monitor III is not equipped with a bleeder resistor, the CRT retains a high-voltage charge even when the monitor is turned off. To ensure your safety, the following precautions must be taken when removing the rear cover of the Monitor III:

- **Do not work on the monitor alone.**

If there is an accident, it could save your life to have someone else nearby. Apple recommends that your staff be trained in cardio-pulmonary resuscitation (CPR).

- **Remove rings, wristwatches, bracelets, hanging necklaces, and other jewelry before removing the back of the monitor.**

Metal jewelry is an excellent conductor of electricity. Removing jewelry will reduce the possibility of electric shock.

- **Wear safety goggles.**

The CRT contains a high vacuum. If cracked or broken, it can implode (collapse into itself), then explode. To protect your eyes from serious injury, always wear safety goggles when working on or near a CRT.

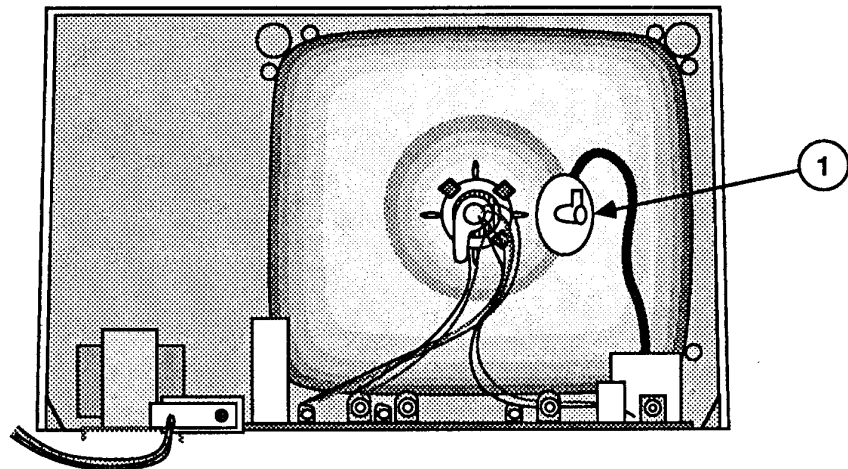

**FIGURE 1**

- **Never touch the anode connector or the anode aperture.**

Normally the anode aperture has a connector plugged into it (Figure 1, #1). When a CRT is replaced, the anode connector is removed, exposing the anode. Without a bleeder resistor, the anode can retain a charge of several thousand volts (even when power is off).

- **Before removing the monitor cover, turn off the power and disconnect the AC power cord.**

Certain parts of a monitor chassis are hot (electrified) when the monitor is under power. Except when you must have the power on (for example, when making live adjustments), never work on a plugged-in monitor—even if you have the power turned off.

- **Be careful of the CRT neck.**

To prevent an implosion, you should take every precaution against breaking the tube, especially at the neck, where the tube is the thinnest.

## □ EXCHANGE PROCEDURE

### Materials Required

#2 Phillips screwdriver

### Rear Cover Removal

To remove the rear cover of the Monitor III:

1. Turn the monitor off and disconnect the AC power cord.
2. Place the monitor face down on a soft, protective surface.
3. Remove the two Phillips screws (Figure 2, #1) located on the bottom of the monitor case.

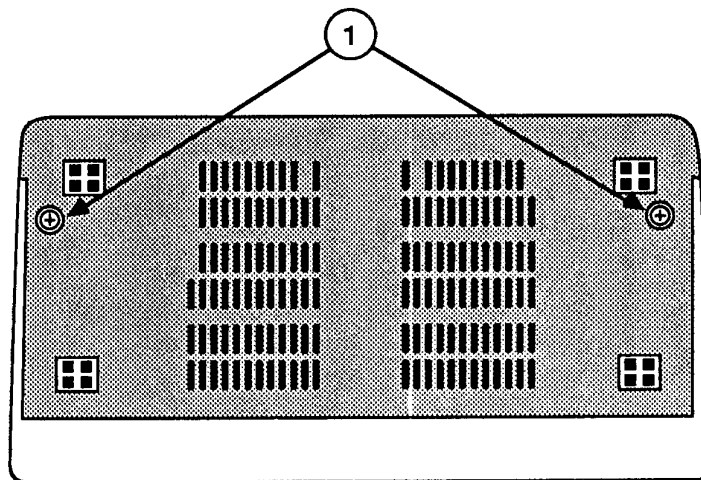

FIGURE 2

4. Remove the single screw (Figure 3, #1) located inside the top handle on the monitor case.
5. Remove the line cord molding screw (Figure 3, #2).
6. Slide the line cord molding (Figure 3, #3) to the left 1/8th inch. Gently push the molding inside the rear cover.
7. Carefully lift the rear cover off the chassis frame, while feeding the line cord (Figure 3, #4) through the opening on the rear cover. Set the rear cover aside.

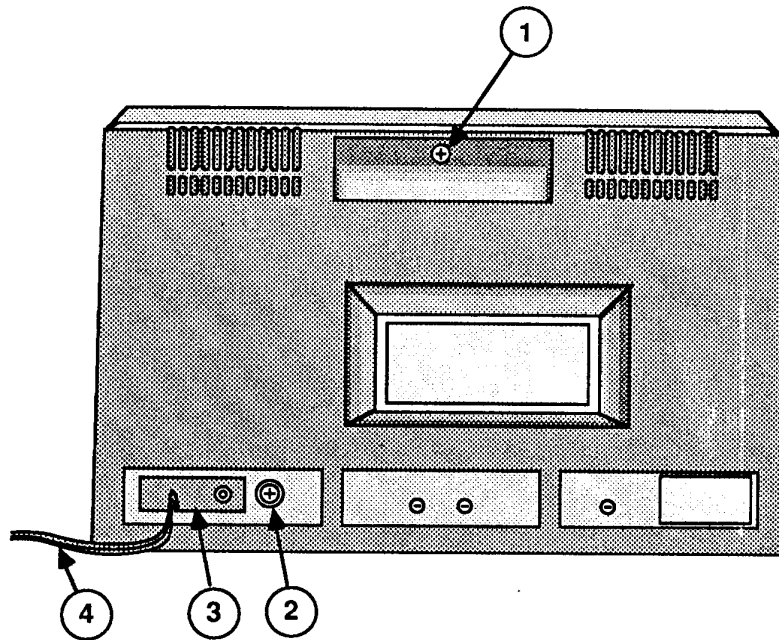

FIGURE 3

8. When the rear cover is off, do not touch the yoke wires (Figure 4, #1), the anode connector (Figure 4, #2), the anode wire (Figure 4, #3), or the flyback transformer (Figure 4, #4).

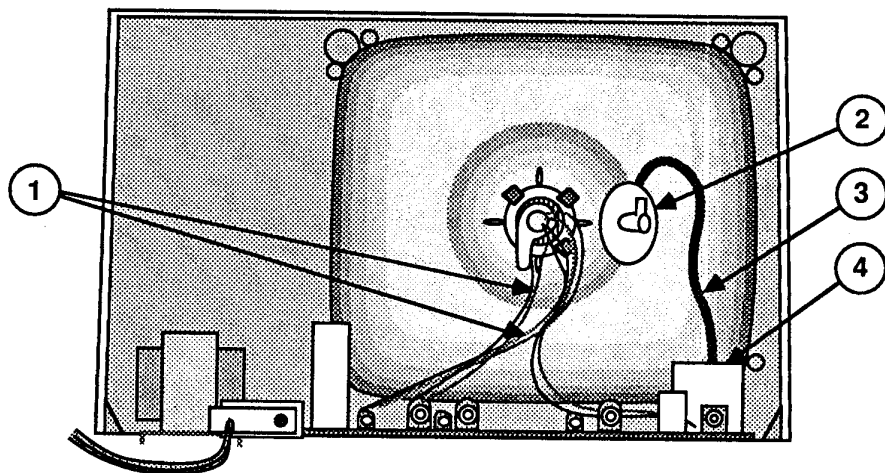

FIGURE 4

### Rear Cover Installation

To install the rear cover or shipping fixture on the back of the Monitor III:

1. Feed the line cord (Figure 5, #4) through the opening on the rear cover and lower the rear cover onto the monitor chassis. Position the rear cover so that the two inside slots fit over the sides of the deflection board as you lower the rear cover onto the monitor chassis.
2. Pull the line cord molding (Figure 5, #3) through the opening on the rear cover and slide the molding to the right 1/8th inch.
3. Replace the line cord molding screw (Figure 5, #2).

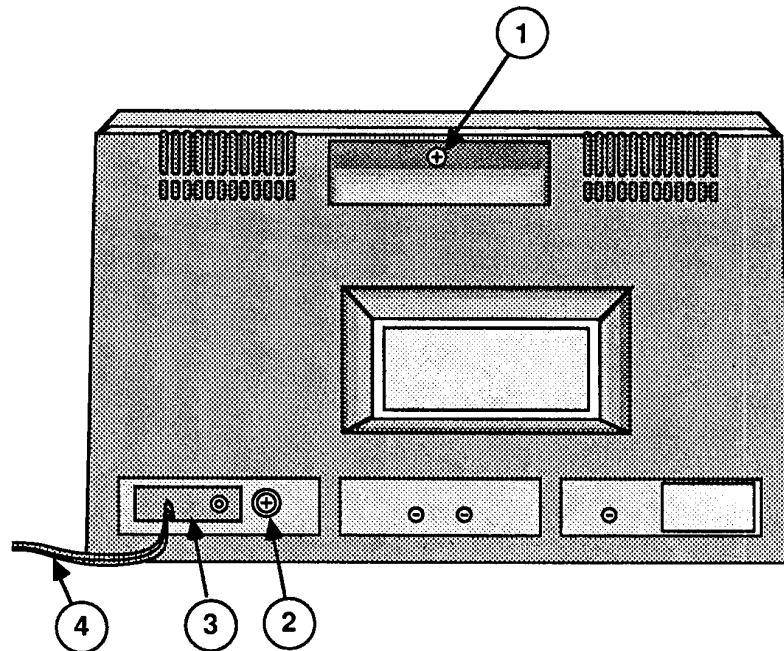
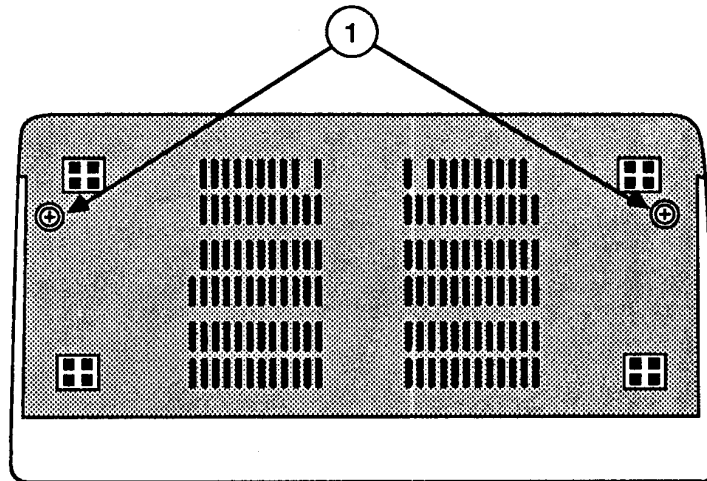

FIGURE 5

4. Replace the single screw (Figure 5, #1) located inside the top handle on the rear cover.



5. Replace the two Phillips screws (Figure 6, #1) located on the bottom of the chassis frame.



**FIGURE 6**

6. Carefully set the monitor upright.



Apple II



Apple IIe  
(late model)



Apple IIc

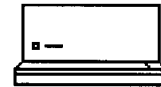

Apple IIGS



Disk II

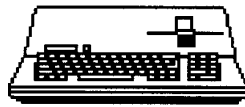

Apple III

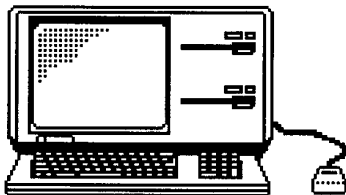
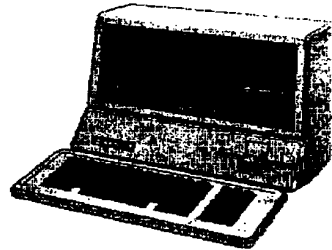

Lisa



Lisa 2

# End of Apple Service Repair Information

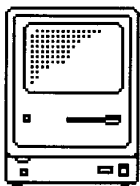

Macintosh 128

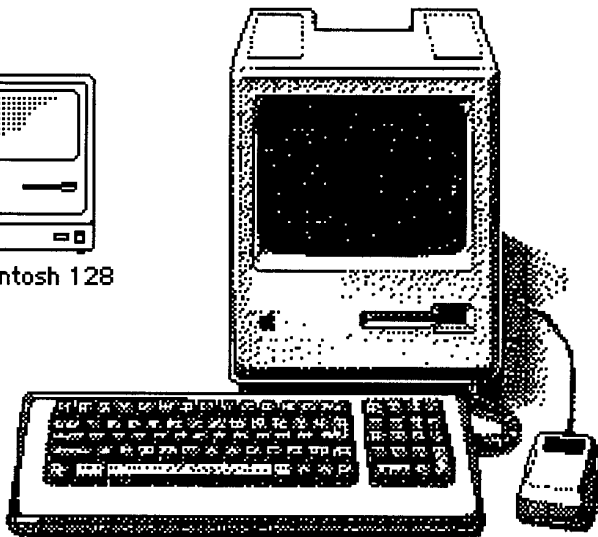

Macintosh Plus



Macintosh II

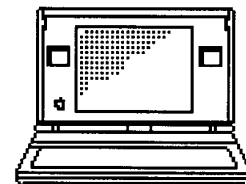

Portable Macintosh

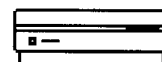

Macintosh LC