

Document # 326

Apple Lisa Information

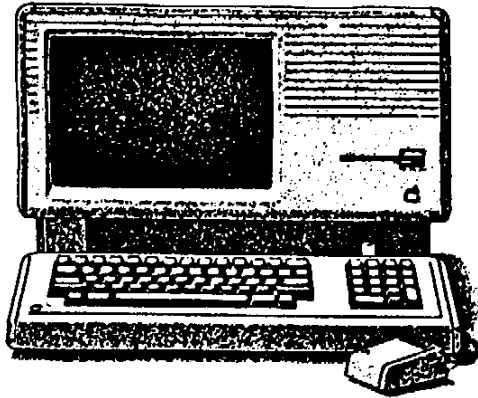

FILE NAME  
*Lisa MRD*

DISK #

COMMENTS  
*Apple - 1980*

David T. Craig  
736 Edgewater, Wichita, Kansas 67230  
(316) 733-0914



The *Lisa*  
Professional



LISA MARKETING REQUIREMENTS  
DOCUMENT

APRIL 18, 1980

TRIP HAWKINS  
GLENN EDENS  
BARRY MARGERUM

**CONFIDENTIAL**

*Pages: 69  
with 6 pages  
for title and  
other special  
pages (eg TOC)*

(i)

LISA MARKETING REQUIREMENTS DOCUMENT

INDEX

1	EXECUTIVE SUMMARY.....	1
2	PROJECT IDENTIFICATION.....	2
3	PRODUCT CONTRIBUTIONS.....	3
4	RELATIONSHIP TO OTHER APPLE PRODUCTS.....	4
4.1	The Road To The Office Of The Future.....	4
4.2	Attacking From Both Ends.....	5
5	MAJOR MARKET OPPORTUNITIES.....	8
5.1	The Office.....	8
5.1.1	The Opportunity.....	8
5.1.2	Customer Profile.....	12
5.1.3	Productivity Gain Objectives.....	12
5.2	Accounting/Small Businesses.....	15
5.2.1	The Opportunity.....	15
5.2.2	Customer Profile.....	15
6	FUNCTIONAL OBJECTIVES.....	17
6.1	Product Life.....	17
6.2	Price Objectives.....	17
6.3	Appearance.....	17
6.4	Packaging.....	17
6.5	Environmental Requirements.....	18
6.6	Display.....	18
6.7	Speaker.....	19
6.8	Keyboard.....	19
6.9	Pointing Device.....	20
6.10	Memory.....	22
6.11	Mass Storage.....	22
6.12	Telecommunications.....	23
6.12.1	Telephone, Voice, & Modem.....	23
6.12.2	RS232C Interface.....	24
6.12.3	Terminal Emulation.....	24
6.12.4	Facsimile.....	25
6.12.5	High Speed Modem.....	25

INDEX

6.13	Networking.....	25
6.14	Printers.....	26
6.15	GPIB Interface Card.....	27
6.16	Configurations and Priorities.....	28
6.17	System Software.....	30
6.17.1	Operating System.....	30
6.17.2	Development Tools.....	31
6.18	Applications Software.....	32
6.18.1	Objectives.....	32
6.18.2	Overview Of The Business Assistant.....	34
6.18.3	Visicabinet.....	34
6.18.4	Word Processor.....	37
6.18.5	Graphics Editor.....	39
6.18.6	Business Graphics.....	39
6.18.7	Personal Applications.....	42
6.18.8	Accounting Applications.....	43
6.18.9	Outside Software Development.....	44
6.19	Compatibility.....	46
7	PUBLICATIONS.....	47
8	MANUFACTURING.....	49
9	SERVICE/SUPPORT.....	50
9.1	Hotline.....	50
9.2	Installation.....	50
9.3	Diagnosis.....	50
9.4	Service Design.....	50
9.5	Level 2 Service.....	51
10	SALES AND DISTRIBUTION.....	52
11	INTERNATIONAL MARKETING ISSUES.....	54
12	LONG-TERM PRODUCT AND MARKET OVERVIEW.....	56
12.1	Technology Outlook.....	56
12.2	Facsimile.....	58
12.3	Printing.....	58
12.4	Microfilm.....	60
12.5	OCR.....	60

INDEX

12.6	Telephones & PABX.....	61
12.7	TWX, TELEX, & Electronic Mail.....	61
12.8	Phototypesetting.....	61
13	PRODUCT LINE TIMETABLE.....	63
14	COMPETITIVE PRODUCTS.....	67

(iv)

LISA MRD/PRD AMENDMENTS

I. ADDITIONAL LISA MRDS

Some areas covered in the MRD will adhere to the direction stated but will be subject to change until detailed, separate MRDs are prepared for each one. These areas, and the target completion date for each, are as follows:

1. USER INTERFACE	May 31, 1980
2. SOFTWARE THEFT PROTECTION	May 31, 1980
3. USER SET-UP AND CUSTOMIZING	June 30, 1980
4. TERMINAL EMULATION	June 30, 1980
5. VISICABINET	June 30, 1980
6. WORD PROCESSOR	June 30, 1980
7. GRAPHICS EDITOR	June 30, 1980
8. PERSONAL APPLICATIONS	June 30, 1980
9. MASS STORAGE PERIPHERALS	June 30, 1980
10. PRINTERS	June 30, 1980
11. NETWORKING AND ELECTRONIC MAIL	July 31, 1980
12. DIAGNOSTICS/TESTING	July 31, 1980
13. BUSINESS GRAPHICS	July 31, 1980
14. INTRODUCTORY INTERACTIVE MANUAL	August 31, 1980
15. OEM PRODUCTS (DEVELOPMENT TOOLS)	August 31, 1980

II. HARDWARE ENGINEERING AMENDMENTS

1. Both Alps and Keyboard Co. (bucket) keyswitches will be pursued as potential options at introduction. Other keyboard technologies will be investigated in parallel but may not be available at introduction. If a better alternative does turn up, it could be made available within a few months of introduction, either as a standard keyboard or as an option. Although the keyboard layout is nearly final, it has not frozen since it is not yet on the critical path. One remaining potential variation is the possible removal of the cursor cluster from the layout.

2. Engineering is concerned that the current cost objectives may not be feasible.

3. Although there is no requirement to have the Problem Analysis Guide (PAG) stowed within LISA, Engineering will continue to pursue methods by which the PAG may be attached to the main unit.

4. The current display has a refresh rate of 59.2 Hz, which violates the requirement of being within 1% of 60 Hz. Engineering will arrange for a side-by-side demonstration of the 59.2 Hz display against an identical 60 Hz display to see if the 59.2 version meets the product's requirement.

(v)

### III. SOFTWARE ENGINEERING AMENDMENTS

1. It is too early to tell whether or not it will be possible to provide the level of integration and software sophistication desired on a 128K LISA. Future MRDs and performance analyses will resolve this issue.
2. Visicalc capabilities will be either built-into the File Cabinet to create the "VISICABINET" concept, or created as a separate product. This concern will be resolved in the VISICABINET MRD.
3. Implementation details of the user interface may have a significant impact on performance and product schedules. These details will be resolved by May 1, 1980.
4. The degree of integration of the various software modules has not been determined. Final resolution will involve basic capability/performance tradeoffs.

### IV. INTRODUCTION TARGET DATES

The LISA system will be available for first shipments (i.e., introduction) by March 23, 1981, the date of the National Computer Conference Office Automation Show in Atlanta. Peripherals and software will be available as noted in the Product Line Timetable, with the following exceptions:

1. The File Cabinet, without Visicalc capabilities, is targeted for first shipments on June 30, 1981.
2. Visicalc capabilities are a sufficient unknown that no goal has as yet been set.
3. The Asynchronous Terminal Emulator capability will have a goal of first shipments within 6 months of introduction.
4. As part of the Applenet introduction (6 months after LISA introduction), additional software will be required to allow for sharing disks and printers (i.e., file and printer servers). These are scheduled for shipment simultaneously with Applenet.

(vi)

LISA MARKETING REQUIREMENTS DOCUMENT

1 EXECUTIVE SUMMARY

There is a major market opportunity to provide the complete, personal tool for dramatically improving the productivity of the typical office occupant (secretary or manager).

Apple hopes to meet this opportunity with a distinctive strategy consisting of the following key elements:

**MAJOR MARKET SEGMENT** -- The non-technical office occupant (5 million secretaries and 10 million managers). Secondary markets are analytical managers, executives, and small businesses.

**PRODUCT** -- A combination of enhanced but known technologies that provide comprehensive capabilities for allowing a non-technical person to interact with a computer. While LISA is above all an outstanding general purpose microcomputer, it is targeted as a software solution to the routine, daily tasks in the office. Key features are extensive use of graphics (black on white), an extremely easy to learn user interface, and powerful, integrated tools for managing text and data information. In addition, LISA must represent a good tool (not solution) in other markets where Apple lacks the resources to provide applications software.

**PRICING** -- Substantially below key competitors; low enough that system can be justified for one person using just one or two applications; base price under \$5,000 to allow lower organizational levels to make decision.

**MARKETING COMMUNICATIONS** -- Aggressive spending to attract customers and create image of Apple corporate size and reputation; National media directed at manager, local advertising and promotion directed more at secretaries; Key concepts are to create positive associations (like owning a car) and the image of the system as providing job enrichment, improved productivity, and fun.

**DISTRIBUTION** -- Key OEMs and captive key account salesmen for Fortune 1500 (the "call-on" trade); Professional Systems Dealers and showrooms for medium sized companies; Retail stores for small businesses (the "walk-in" trade).



## 2 PROJECT IDENTIFICATION

LISA is an integrated, stand-alone, single-user microcomputer system product line.

The original source documents for the LISA project are "LISA Proposal #1" (Steve Jobs, October 18, 1978) and "Review of LISA Objectives" (Ken Rothmuller, Document WD 79-17, February 13, 1979). The primary lab project at present is E16; additional project numbers are assigned for Applenet (E66) and various software projects (E108 through E112).

### 3 PRODUCT CONTRIBUTIONS

The primary objective of LISA is to provide the cornerstone around which we can build Apple Computer into a \$500 million dollar per year company. In order to do this, the product must allow us to make a unique contribution to a large segment of the small computer marketplace. Therefore, LISA should:

1. Become as vital and taken for granted in the office of the 1980's as the IBM Selectric typewriter was in the 1970's. LISA will achieve the same image of professionalism and quality and become the heart of the modern office.
2. Solve the common, routine, everyday information processing problems that are found in the same offices where IBM Selectric typewriters are currently found.
3. Make significant strides towards allowing users to solve their individual business problems without the need of conventional programming languages.
4. Augment or replace a majority of today's conventional office tools (e.g., Selectric, terminal, calculator, copier, file, inter-office mail system, calendar, etc.).
5. Portray a friendlier "personality" and "disposition" than ordinary computers to allow first-time users to develop the same emotional attachment with their system that they have with their car or their stereo.
6. Represent a new generation in the Apple family -- a new computer system architecture with a long lifetime and the capability through cost reductions to ultimately address many market segments including the consumer market.
7. Provide Apple with the maximum opportunity to "add value"-- by allowing Apple to capture the market for LISA memory, disks, displays, and other subsystems (including software to some extent). This fact allows Apple to exploit opportunities in manufacturing (e.g., disks, keyboards, modems, etc.).
8. Achieve unit sales of 3,000, 12,000, 14,000, and 16,000 units in the first four, six-month increments after introduction.
9. Become Apple's first product line to generate at least one billion dollars in company revenue.

#### 4 RELATIONSHIP TO OTHER APPLE PRODUCTS

LISA and Apple III compare roughly as follows:

<u>APPLE III</u>	<u>LISA</u>
o Portable	o Integrated
o "Microcomputer"	o "Office System"
o Limited, attached keyboard	o Detachable, flexible typing keyboard
o 8-bit 6502	o 16-bit 68000
o Color and text mode	o Bit-mapped black on white
o Evolutionary	o Revolutionary
o One year head start	o More time to do it right

LISA is a new generation of products, whereas Apple III is largely a derivative from Apple II. In the long run LISA will provide better opportunities for cost reduction, enhancement, product line variation, system flexibility, and a superior development environment.

There are two important concepts having to do with the relationship between Apple III and LISA. These concepts are illustrated in Figures One and Two below.

##### 4.1 THE ROAD TO THE OFFICE OF THE FUTURE

Figure One illustrates "the road to the office of the future." Apple II, thanks to products like Visicalc, Apple Writer, The Controller, Nestar Model A, and others, has helped us get an education about the office and business uses of personal computers. In addition, the product's appearance and our solid advertising has helped to build our image as a supplier of office equipment.

But as an office system, the Apple II is running out of gas. So along comes Apple III with lots of fuel— 80 x 24 display, lower case keyboard, word processing software, extended Visicalc, and higher performance. So Apple II wisely takes a detour and heads for other markets, such as educational and hobby computing. And off heads Apple III for the office of the future.

Apple III makes serious progress, but ultimately falls short. The system has a "microcomputer" image. It's not integrated. The human interface is acceptable but not excellent. The 6502 is getting old. The keyboard is

not optimized for typing. Nevertheless, Apple III gets onto the market early, racks up some sales, helps us build new distribution channels, and gives us another year of market experience selling and supporting office customers.

Along comes LISA. For awhile, they coexist in the office, but eventually LISA has the strength to keep going and Apple III takes a side street to markets where it is relatively stronger-- such as scientific, industrial, and analytical professional. If Apple III has done its job right, it is a portable desktop system backed with a superb library of analytical, problem-solving software. And, selling to an intelligent, analytical, somewhat technical audience, Apple III keeps going strong. Meanwhile, LISA heads for the office of the future!

#### 4.2 ATTACKING FROM BOTH ENDS

Which brings us to Figure Two. If you look at all customers on a scale measuring sophistication, Apple III's best strategy is to evolve the existing customer base from the top-- aiming at the largest available technical and analytical audiences, and expanding downwards. Apple III should focus on software tools that help sophisticated people make important ANALYTICAL DECISIONS.

LISA's approach is the opposite-- going hard after the problems of the non-technical, non-analytical, unsophisticated clerical or secretarial person. LISA's initial focus is on improving productivity in ROUTINE tasks. LISA will then expand on this from the bottom up and go after the most potentially lucrative part of the office system market-- middle managers. LISA will attack his major problem-- getting the INFORMATION to make decisions. Networking and a sophisticated data base system will do the job. It will probably be 1982 before LISA can go after the analytical decisions as well.

The result is two products that can survive SYNERGISTICALLY! The OBVIOUS strategy is to FOCUS Apple III software resources on analytical problem solving and focus LISA on the more mundane routine tasks and heavier information processing applications. Then, after creating a product for one system, we can evaluate the merits of adapting it to the other. For example, LISA can use financial and statistical algorithms written in Pascal for Apple III. Meanwhile, LISA can ponder the unsolved problem of how to replace the Rolodex and the Daytimer, and pass the answers back to Apple III. This is the only approach that will allow Apple to manage its new product growth in any reasonable fashion.

THE ROAD TO THE OFFICE OF THE FUTURE

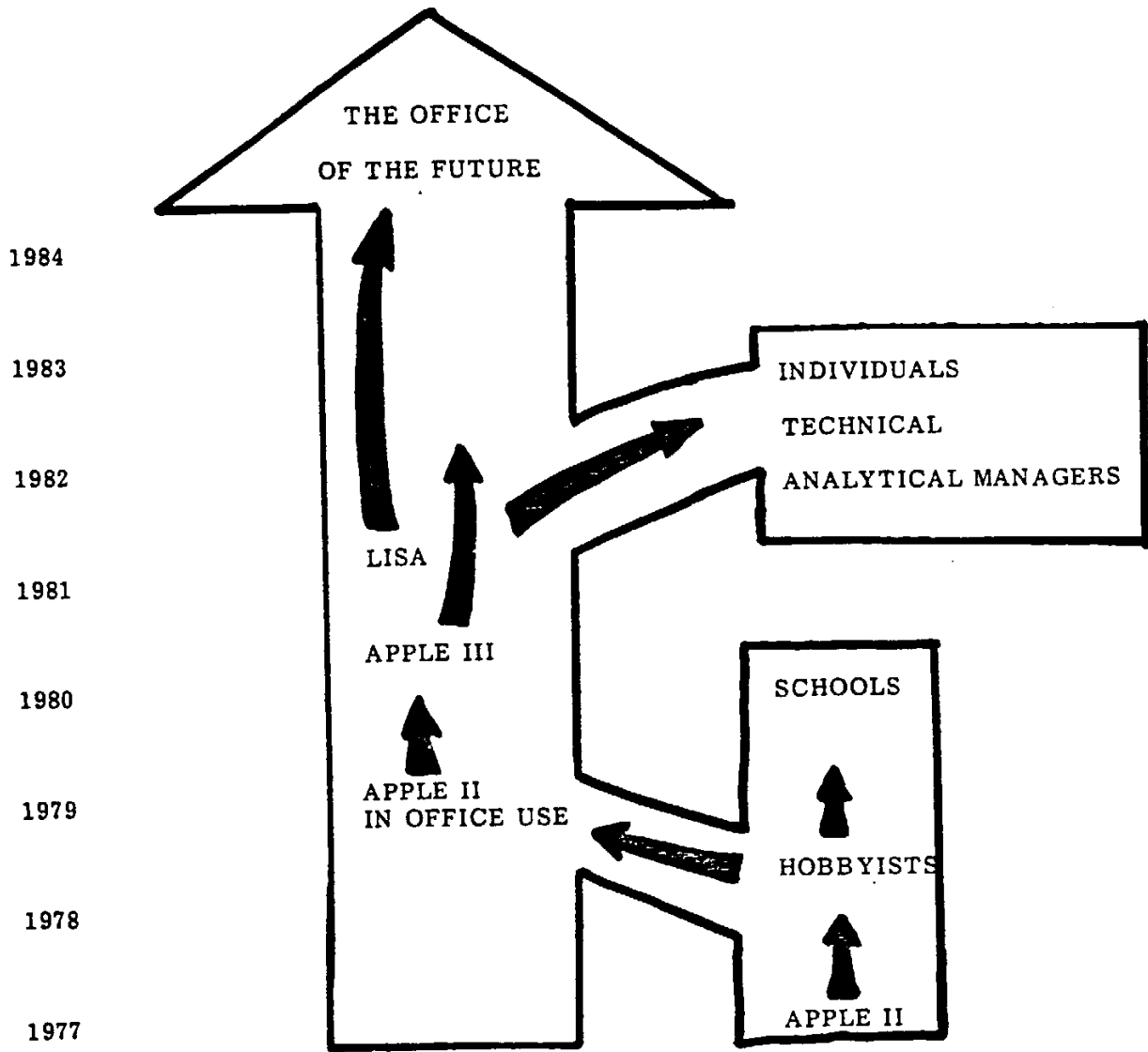

Figure One

LONG-TERM APPLE III - LISA STRATEGY

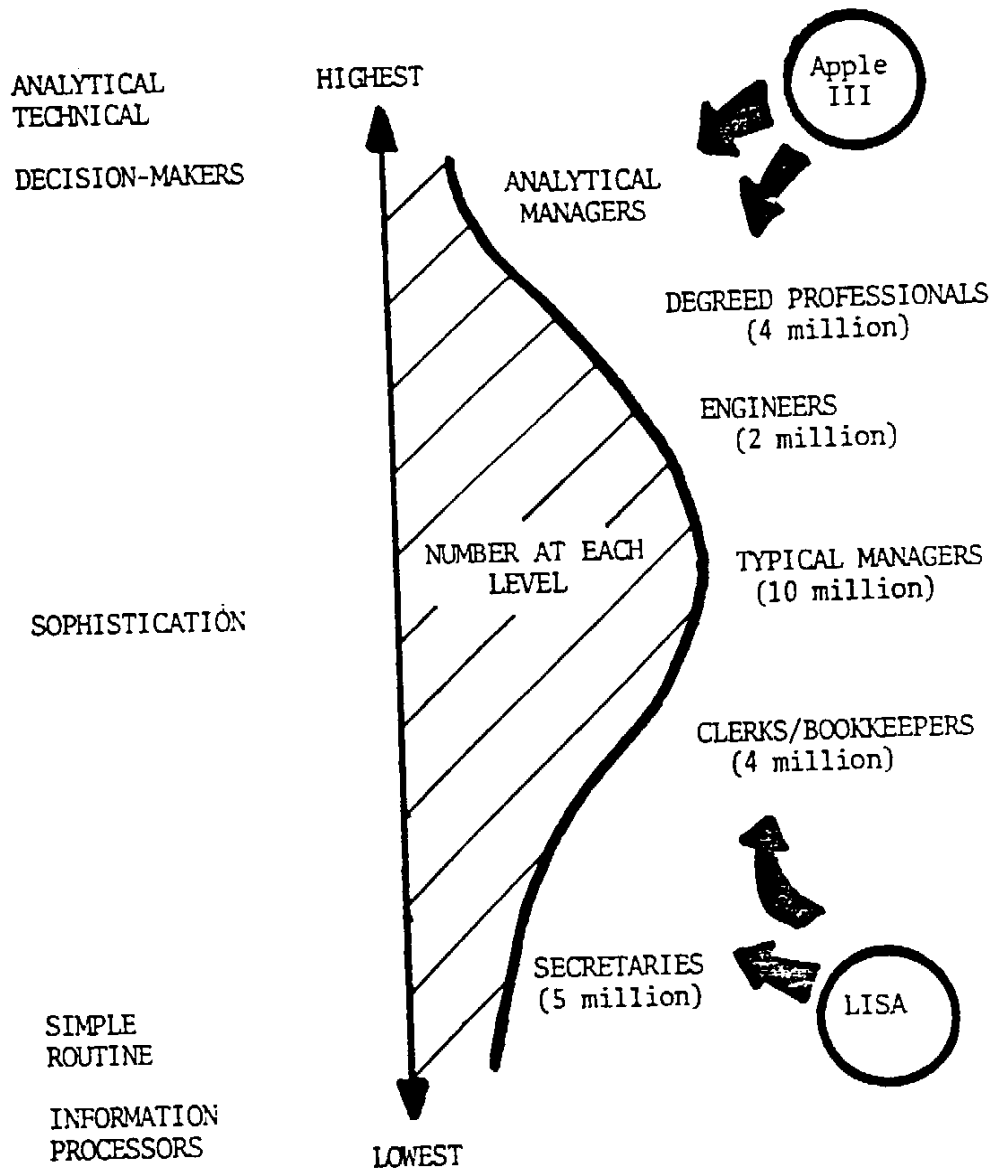

Figure Two

## 5 MAJOR MARKET OPPORTUNITIES

The major LISA market opportunities can be divided into two major classes:

1. General office processing
2. Small business accounting and data processing

During the first year, general office use will dominate sales with a 90% share. By 1983, the accounting segment share will rise to 25%. Overall sales trends are shown in Table One and graphically illustrated in Figures Three and Four.

### 5.1 THE OFFICE

In 1979, U.S. businesses spent \$800 billion on office operations. Of this amount, \$200 billion was for "indirect" costs including support, space, materials, and equipment. The major cost, accounting for \$600 billion, is the direct cost of compensation and fringe benefits for employees. Industry analysts expect that unless major new technologies move into the office, these direct costs will rise to \$1.5 trillion by 1990.

Each year U.S. businesses create 72 billion documents. One large firm studied its paper flow and found that 75% of all correspondence in the firm was internal; that an average of 19 copies were made of each piece of internal correspondence; that these copies were physically distributed throughout the firm; and that less than 5% were ever looked at again. Industry analysts consider these findings typical, and claim that the potential to reduce paper costs may be the greatest long-term application of office technology. Paper costs have risen 35% during the last three years, from \$3.10 per 1000 sheets to \$4.20.

#### 5.1.1 THE OPPORTUNITY

A major opportunity exists to provide a product that can substantially increase the productivity of the typical office occupants (secretaries and managers) and yet be personal and inexpensive enough that it can be dedicated to one employee and purchased at fairly low levels of authority in the organization. Current office systems are so expensive as to require office reorganization, sharing, and ultimately a great deal of thought and planning on the part of the customer. This has resulted in the major suppliers (IBM, XEROX, WANG, etc.) providing several months of sales support and "free consulting" prior to the sale, usually resulting in the purchase of an "integrated office system" costing in excess of \$50,000.

Apple's opportunity is to provide a personal solution with an integrated set of tools that will improve one person's productivity enough to justify the purchase of the system. If Apple can succeed in "planting an Apple seed" in an organization, over time it may be possible to grow an entire orchard. This approach will set us apart from the major suppliers who will be attempting to sell a much more expensive alternative all at once to

LISA FORECAST 2-80

	1981	1982	1983	1984	1985	1986	BEYOND	TOTAL
UNITS	15000	30000	50000	70000	50000	20000	15000	250000
USE TYPE								
GENERAL OFFICE USE	13500	22500	35000	49000	35000	14000	10500	179500
ACCOUNTING	750	6000	12500	17500	12500	5000	3750	58000
OTHER	750	1500	2500	3500	2500	1000	750	12500
USER TYPES								
SECRETARIES	10125	14625	20300	26950	17850	7000	5250	102100
MANAGERS/OWNERS	2850	8250	15650	23275	17325	6930	5198	79478
BOOKKEEPERS	600	4500	8750	11375	8125	3250	2438	39038
EXECUTIVES	675	1125	2800	4900	4200	1820	1365	16885
OTHER	750	1500	2500	3500	2500	1000	750	12500
	1981	1982	1983	1984	1985	1986	1987	TOTAL
PERCENT								
USE TYPE								
GENERAL OFFICE USE	90	75	70	70	70	70	70	72
ACCOUNTING	5	20	25	25	25	25	25	23
OTHER	5	5	5	5	5	5	5	5
USER TYPE								
SECRETARIES	68	49	41	39	36	35	35	41
MANAGERS/OWNERS	19	28	31	33	35	35	35	32
BOOKKEEPERS	4	15	18	16	16	16	16	16
EXECUTIVES	5	4	6	7	8	9	9	7
OTHER	5	5	5	5	5	5	5	5
AS PCT. OF OFFICE								
SECRETARIES	100	100	100	100	100	100	100	100
MANAGERS	75	65	58	55	51	50	50	57
EXECUTIVES	20	30	34	35	37	37	37	33
BOOKKEEPERS	5	5	8	10	12	13	13	10
AS PCT. OF ACCTG.								
OWNER/MANAGERS	100	100	100	100	100	100	100	100
BOOKKEEPERS	20	25	30	35	35	35	35	30
	80	75	70	65	65	65	65	70

Table One



TYPES OF APPLICATIONS FOR LISA

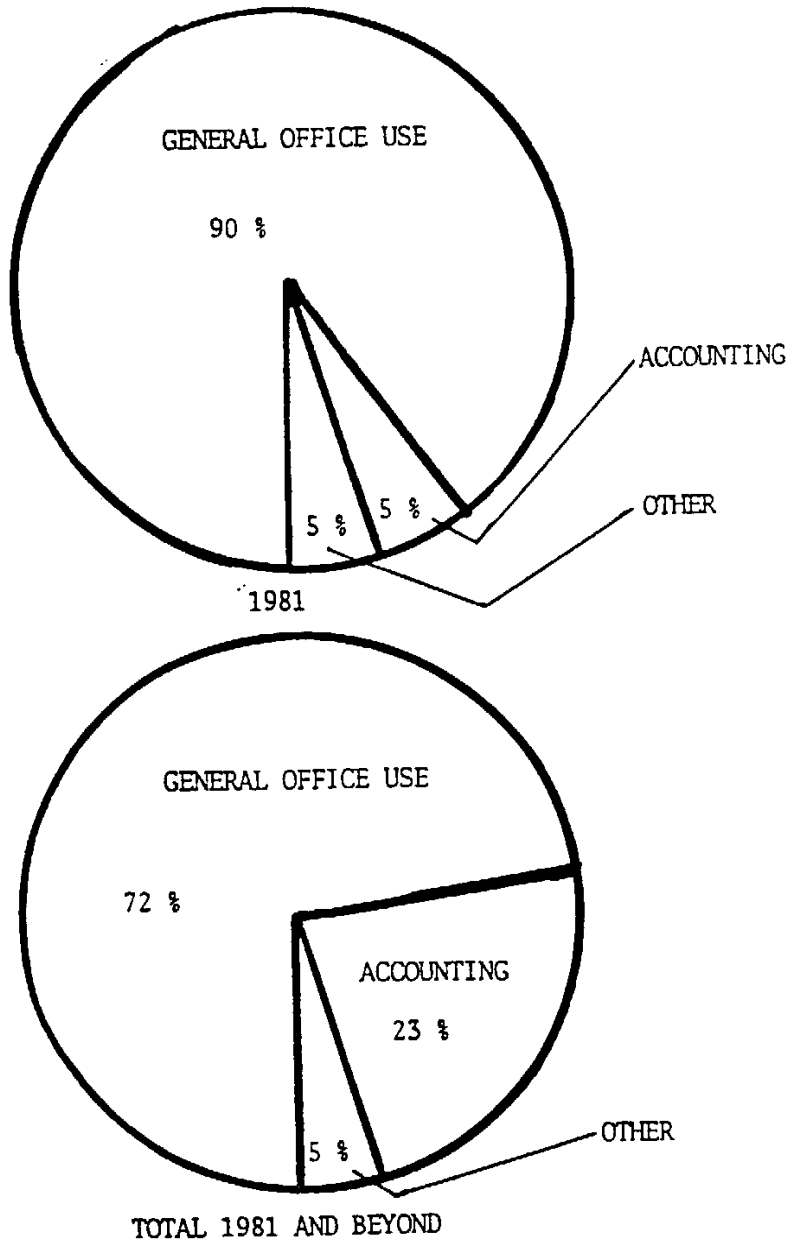

Figure Three

TYPES OF PEOPLE USING LISA

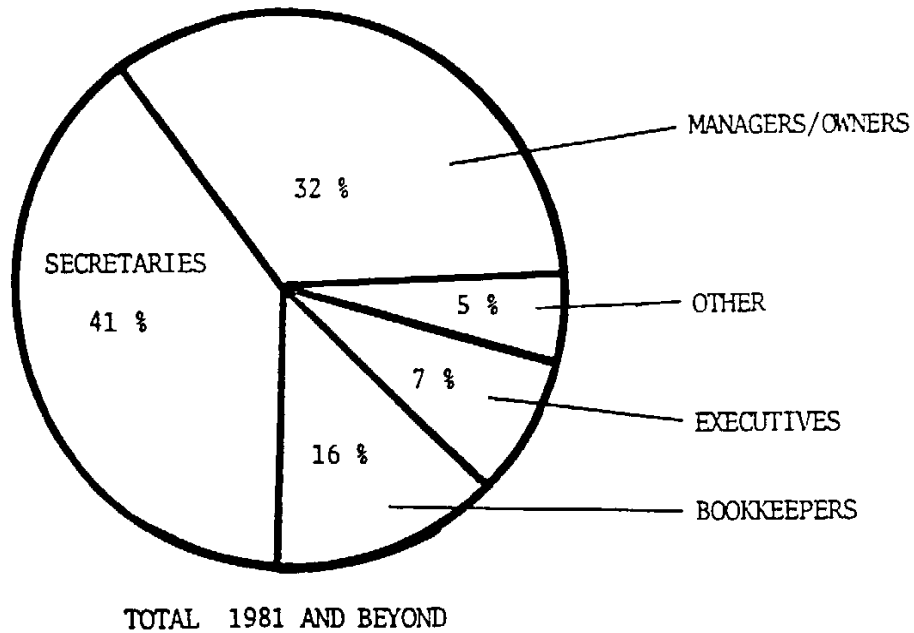
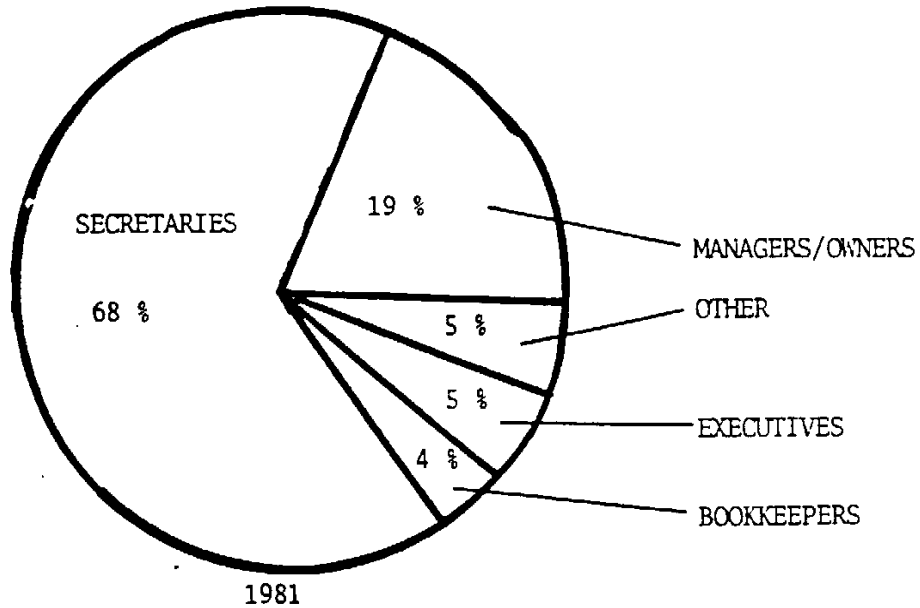

Figure Four

higher levels of management in the firm. In addition, an even greater relative edge will be available to Apple in medium sized companies (\$2,000,000 to \$100,000,000 in annual sales) that do not get as much attention from IBM et al. and are more price conscious.

### 5.1.2 CUSTOMER PROFILE

The Fortune 1500 are roughly those firms that are over \$100 million in annual sales, while medium sized firms range in size from \$2 million to \$100 million in annual sales. Small firms here are those under \$2 million in annual sales that are buying the system primarily for its general office information processing capability. The last group consists of law firms and other professional groups (accounting firms, consulting firms, etc.).

Initially the overall mix of users in the office market will be slanted more heavily towards secretaries, but since their primary function is to improve the productivity of the manager, both need to be considered. For our purposes, we must assume that our typical user is a first-time user who will over a period of three months become an efficient operator.

SECRETARIES spend a typical day as follows: 2 hours typing, 1 hour on the phone or arranging travel, 1 hour copying and distributing information, 30 minutes scheduling meetings, 1 hour proofreading, and the remainder on miscellaneous projects. Most of this activity centers around the information sought or generated by the secretary's manager.

MANAGERS activities vary according to the field or department, but include reading through an in basket, phone calls, supervising and tracking projects, calling and attending meetings, preparing budgets, forecasts, and financial models, and writing memos and letters.

EXECUTIVES spend more time filtering input from managers and making policy decisions, but due to their position in the organization, they need access to a greater variety of information resources than the typical manager. Also, the executive is likely to feel negatively about the idea of a "computer terminal and keyboard" in his office.

### 5.1.3 PRODUCTIVITY GAIN OBJECTIVES

Since office productivity is the key to holding down direct costs associated with the office, the justification for LISA's purchase will be based on the perceived productivity gains that it offers. What follows is a discussion of how LISA will affect various office tasks in the future:

1. Document Preparation -- The major benefits derived from a word processor come from the reduced time for retrieving and filing documents, editing, and reformatting text. LISA should provide productivity gains of up to 100% in a typing pool environment and 50% in a normal secretarial environment, over the Selectric II typewriter. For example, if a person spends 2 hours typing a day, a 100% productivity gain implies it would only take 1 hour per day with LISA.

A good example is this MRD; LISA should be able to generate the entire document including tables, figures, and multiple fonts!

2. Calculation -- In general, calculators are used for simple arithmetic functions. Initially, LISA won't significantly improve the users productivity over current calculators, but eventually, it will make people more productive by 1) making functions available that were not previously being used, 2) ensuring that they utilize these functions by assisting them in data entry so that both unfamiliar and infrequent users can take advantage of the system. The productivity gain increase should be 100%.

3. Record Keeping/Filing -- Retrieving information that has been filed can be a very time consuming endeavor. Initially, productivity gains should be 5% in locating names, addresses, typed documents, and department records. Later, when Applenet or more disk space is available, productivity gains should be 20% for securing typed documents or memos received internally. Finally, when microfilm becomes available on LISA, the user should realize productivity gains of 300% when they have access to all documents.

4. Scheduling -- This is divided into planning individual schedules and arranging meetings. An automated calendar scheduler may not significantly improve productivity in planning a single schedule, but it will improve the accuracy and attendance. At present, people spend large amounts time trying to schedule meetings. Combined with networking, the scheduler in LISA should improve their productivity by 300% (for large meetings up to 900%).

5. Phone Activity -- The time spent trying to reach someone on the phone can be reduced by LISA's ability to look up numbers, dial quickly, and retry until the party answers. The productivity gains are 10%.

6. Distribution -- With the advent of Applenet, the necessity of copying documents and distributing them will be greatly reduced. In addition, connecting an intelligent copier to LISA will provide the ability to make multiple copies without intervention. Therefore the improvements in productivity should be 400%.

7. Communication -- The use of graphics to provide a visual representation of a complex idea or thought will greatly improve communications. This increase in productivity of communicating is immeasurable. Distribution of information either locally or nationwide should be greatly improved with the use of LISA. Using LISA to send information via TWX, TELEX, facsimile, or other methods should permit productivity gains of 100%.

8. Information Processing and Reporting -- The system should allow a non-computer oriented person the ability to create forms for input of new data and provide reports with a minimal amount of effort. The time necessary for creating and generating reports should be significantly lower than it is today. In addition to quickly getting

information that wasn't previously available, the user will be able to instantly and automatically convert this information into a graphic format, which will make the review of such information easier and more informative. The productivity gain is limitless, because better, more accurate, and more timely information provides a setting for better decision making.

9. Work Quality -- LISA will permit different output options that are of higher quality than is currently available on microcomputers. A variety of fonts, icons, and graphics should allow the user to create reports, memos, or other output that is easier and more pleasing to read than is currently available.

10. Analysis -- The ability to have a computer that permits the user to easily and quickly ask "what if?" questions greatly improves the users decision making capabilities. A dedicated LISA will instantly provide a reliable resource for such questions and make the user immeasurably more productive.

## 5.2 ACCOUNTING/ SMALL BUSINESSES

Very small businesses are treated as a separate market segment from the office segment, since the primary function is accounting. Our market segment consists of firms that cannot afford to spend \$20,000 for a true multi-user system and are looking to spend under \$10,000 initially for a single-user system. These firms typically have sales under \$2 million.

### 5.2.1 THE OPPORTUNITY

There are a number of reasons why it makes sense to offer LISA to the very small business market as a DP/Accounting computer system:

1. Apple already serves the market
2. Our current distribution is best equipped to sell to the market
3. LISA will be the first Apple product to physically LOOK like a small business system
4. LISA's File Cabinet capabilities will give the small business user unparalleled flexibility in a low-cost system.

This market is not nearly as large as the general office market and requires significantly more specialized applications software than we can expect to introduce for LISA in the next two years. In addition, it is more attractive long-term if LISA makes its major push into this market only after the more substantial portions of the File Cabinet data base system becomes available. This will probably not occur until 1982; in the interim LISA can subsist comfortably by using the Pascal version of The Controller (et al.) developed for the Apple III.

LISA's long-term opportunity in this market is to provide substantially more flexibility and integration of functions than systems that may be less expensive. For this reason, LISA will be targeted at markets where WP and DP applications overlap significantly, and where the File Cabinet can add significantly through customization.

### 5.2.2 CUSTOMER PROFILE

The primary segments envisioned are law offices/CPAs/consultants (client billing), and retailers/wholesalers (inventory/billing). We will also need a general accounting system; in all likelihood it will be two years before all of these needs are addressed. The primary operator of the system is the owner of the business, along with a bookkeeper or secretary. These people are also first-time users.

The full generality of a multi-user distributed processing environment is not needed. What is needed is the ability of two or more users to share access to a file on the hard disk (through a dedicated file server or LISA). Multiple writers would share a file in a multiplexed "one-at-a-time" mode (Nestar has already demonstrated this feature with the

Model A). The important concept here is that true distributed processing systems can be very complex and solving "all" the problems will have only a minimal return on our investment and efforts. The typical applications envisioned can be satisfied by a very simple transaction processing model.

## 6 FUNCTIONAL OBJECTIVES

### 6.1 PRODUCT LIFE

LISA will have a software product life of at least ten years and hardware life cycles of at least three years; to do this the product must not only be highly marketable but must lend itself to future cost reductions and be as manufacturable as possible.

### 6.2 PRICE OBJECTIVES

It is extremely important that LISA be introduced at an end-user price under \$5,000. In order to achieve this, total material costs at introduction cannot exceed \$1,060 and fully burdened manufacturing cost cannot exceed \$1230. The longer term objective is to realize an average annual decline in material costs of 15%, leading to a 1984 materials cost of under \$650. This will allow an end-user price of under \$3,000.

Low price is extremely important for LISA due to Apple's image and methods of distribution. In addition, the combination of price and productivity improvements will allow LISA to provide at least twice the return on investment of the office tools that it replaces or augments.

### 6.3 APPEARANCE

LISA's styling will be highly seductive and will be optimized to appear comfortable in a typical office setting. Color and styling concepts (the Apple "look") will be used to fit easily within modern office decor. The system will appear to be noticeably smaller and more compact than competitive units (e.g., Lanier No Problem Typewriter and CPT Word Processor). The system will convey the image of high reliability, durability, and quality.

### 6.4 PACKAGING

The physical package will adhere to the basic principle that "simplicity is elegance." LISA will have display and mass removable storage built-in. The system will not make any noise at all when sitting idle with the power on, or require a cooling fan (see section 6.5).

LISA will weigh 45 pounds or less. In addition, it will be possible for a typical user to easily disconnect the various modules of the system (keyboard, core electronics, power supply, disk drives, or remaining shell) without danger of electrocution, and move these separately. The keyboard will be detached from the main unit and be provided with a simple, coiled cable that is as easy to disconnect as a modular telephone jack. This cable will comfortably stretch to a usable length of four to six feet. LISA will fit on a standard typing return and not require any special furniture or environmental conditioning.



A connection for an external monitor (Apple supplied-high bandwidth) will be provided on the rear panel of LISA, as well as a jack for an external speaker (which will cut-off the internal speaker).

The feasibility of an anti-theft device will be investigated to help prevent a LISA from being stolen or removed by an unauthorized person.

#### 6.5 ENVIRONMENTAL REQUIREMENTS

LISAs will be found in typical offices in companies of all sizes (see sections 4, 5, 6.3, and 6.4).

LISAs must be operable in a wide variety of environments (e.g., temperature extremes, high dust levels, etc.). The system must be designed to operate with no special environment preparation (e.g., special power plugs, air conditioning, etc.). LISA must meet the environmental specifications of the H-P 85 Personal Computer. LISA will withstand the shock and vibration parameters of a specified Class B environmental test.

LISA will not have a fan. In some cases LISAs will need to operate in high temperature environments. LISA will provide a Level 1 Service Center installable fan to provide additional cooling in high temperature environments (greater than 100 degrees F. ambient temperature).

The system must be designed to sustain loss of 1 cycle of A.C. power (power interruption). The system will operate over a wide range of A.C. voltage fluctuations. The system must operate from 90 to 110 V.A.C., 100-130 V.A.C., and 200-240 V.A.C. at 50Hz or 60Hz. The input voltage must be selectable by the user. An uninterruptable power supply or battery backup option must be available. It is recommended that an external D.C. voltage input plug be provided for this purpose.

The system must meet UL, FCC, CSA, DOT, VDE and other appropriate safety and EMI/RFI regulations.

#### 6.6 DISPLAY

The LISA display must provide a stable, flicker free, and pleasing display to the user. The display character set must be more attractive than the average 5 by 7 or 7 by 9 characters that the user is accustomed to seeing.

Due to the graphics nature of the world (as opposed to pure text) the LISA display must provide for any arbitrary display of graphics information. This includes the ability to "turn on all the dots" for better simulation of paper.

The display color shall be similar to the color values of a standard black and white television set. This color requirement is required to meet the objectives of displaying images such as pictures transmitted from facsimile equipment in a way which will appear "natural" or similar to black and white photographs.

The refresh rate of the display must provide a flicker free display in normal room lighting with all "dots" energized. The refresh rate must be 60 Hz (within 1%). The display must also function in 50 Hz environments (refresh rate may still be 60 Hz).

The display size of the first product offering will be a 12 inch diagonal tube simulating a "half" page as closely as possible. A page is defined as the typical amount of graphics and text information which may be presented on an 8.5 inch by 11 inch piece of paper. Within three years LISA must be available with a "full" page display. This display shall have identical visual appearance to the "half" page display except for information density, monitor orientation, and surface area. All LISA software must be developed with this requirement in mind to make software transition to a full page display painless.

The display must provide some means of reducing operator distraction due to glare or reflections from office surroundings. If a screen device is used it must be removable to allow for cleaning. The normal mode of operation of the display by software shall be black characters and images on a white background. The display must also support reasonable operation with white characters and images on a black background. The system must provide manual adjustments for screen brightness and contrast. The display must be shielded from interference from electromagnetic radiation. A connection for an external monitor (Apple supplied high-bandwidth) will be provided on the rear panel of LISA.

Within two years of product introduction a LISA color display option must be available as a plug-in input/output board option. This option will be capable of accessing color bit-map data and interface to large screen television systems for conference and meeting displays as well as high quality RGB displays. Screen resolution and color capability must be competitive with the IBM 3279 color display and the Tektronix 4027 color. The color display option density will be comparable to the Apple III (SARA).

#### 6.7 SPEAKER

LISA will provide an internal speaker which is capable of providing a variety of audible tones and voice. The audio output level will be user selectable.

#### 6.8 KEYBOARD

The keyboard must be detachable and operable four to six feet from the mainframe. The keyboard must include:

1. Typewriter keyboard
2. Cursor and control keys

3. Numeric pad with calculator keys
4. Soft-key row

Physically the typewriter keyboard layout will be as similar as possible to the IBM Electronic 50 typewriter. All keycaps will be sculptured, IBM dish style shape and be textured for non-glare (see IBM Electronic 50). The keyboard must have positive tactile feedback. The keys will all have smooth surfaces except possibly the numeral 5 on the numeric keypad. Key markings shall be distinct and not cluttered and be similar to the markings of the IBM Electronic 50 typewriter. The keyboard keys and markings shall be limited to a maximum of three colors.

The keyboard enclosure will have positive gripping feet to hold position on formica or metal surfaces. The keyboard feet must not leave marks or deposits on the use surface. The keyboard must provide full protection from spilled liquids (e.g., coffee, etc.) damaging the keyboard. A plastic membrane similar to the IBM 3101 terminal is recommended.

The keyboard cable must be flexible to allow for more than normal bending, twisting, and wear without breaking. The cable must also not interfere with moving LISA from one location to another. To meet these goals the cable will be a coiled cord similar to a standard telephone handset cord. The "pull" of the cable will not be sufficient to move the keyboard across the use surface.

Any other potentially destructive single keystroke key will be physically separate from the four main key areas to avoid accidental pressing.

The LISA keyboard design must allow additional keyboard types to be produced to meet specific application needs or foreign character sets. This requirement implies the keyboard must be inexpensive and that software be able to determine the keyboard type that is currently connected to the LISA.

#### 6.9 POINTING DEVICE

Due to the capabilities and generality of LISA's bit-mapped display, an easy to use, powerful, and efficient pointing device is required for use with LISA at introduction. This device is the primary pointing device and will make it easier for users to position the "cursor" and select targets on the screen as well as facilitating the use of graphics. The pointing device will meet or exceed the following performance criteria:

1. The device must be usable from either side of the keyboard.
2. Homing, or moving a hand from the keyboard to the device to prepare for use, will take less than .36 seconds.
3. The device will provide three keys or buttons for specifying

commands that are used in conjunction with pointing activity.

4. Movement will be possible in both character cell and dot increments.
5. The device will allow a target to be approached equally well from any angle.
6. The rate of movement provided by the device will approach the maximum possible for the information processing capabilities of the eye-hand guidance system.
7. If given 20 trial problems of homing to the device, positioning on a target, and selecting it (with randomly generated targets averaging 4.23 cm in length and 6.13 cm from the cursor), a tested user will be able to:
  - o Average 2.2 sec. positioning time for the first block of 20 trials
  - o Average 5% or fewer errors
  - o Allow an experienced user to select a target that is 16 cm away in 1.5 seconds
  - o Achieve a usage learning curve such that after N blocks of 20 trials each, positioning time improves by the formula:  
$$\text{Pos. Time} = 2.2N^{**}(-0.13)$$
8. The device will interface directly to the main LISA unit (not the keyboard) and not require an I/O slot.

Considerable research has been conducted by S.R.I., Xerox and others on advanced pointing devices. Copies of various articles describing this research are available from Product Marketing.

#### 6.10 MEMORY

LISA must be able to accomodate a larger amount of main memory than currently available office products. This is required to support bit-mapped graphics, to support software with better user interface characteristics, and to provide improved performance.

LISA memory capacities can be divided into two time frames based on advances in semiconductor memory technology. The first LISA product using 16K-bit dynamic RAMs will support a maximum memory size of 256K bytes. The second LISA offering using 64K-bit dynamic RAMs will support a maximum memory size of 896K bytes. The minimum memory size will be 128K bytes.

Reliability and data integrity are very important to the LISA user. Several mechanisms will be available to insure the validity of data in the various components of the LISA system. In the case of main memory, parity checking is the minimum acceptable level approach. For the user desiring better validity checking an optional memory module will be available with error correction and detection (ECC).

The basic user requirement which must be met is that data not be altered due to unreported or undetected memory errors. The unreported error rate must be equal or better than error rates of mainframe computers such as the DEC VAX or the IBM 4300. The worst impact to the user may be the restarting of a task and the loss of all data since information was last written on the disk. This requirement may be met by a combination of hardware error detection circuitry and error detection software.

The expansion memory will be easily installable with only a screwdriver (for removal of back panel only) and will require no setting of switches or attachment of cables. The system software will be able to determine the amount of available memory automatically at system power up.

It is assumed that nearly all program development will be done in PASCAL and that use of a strongly typed high level language can reduce the need for sophisticated memory protection and management hardware. However in many OEM environments some form of memory protection is needed to help protect Apple supplied software from terrible programming accidents. This protection hardware may be very simple; such as a "page protection" scheme with write protect bits (e.g., a bit per 8K bytes, etc.). The important point here is that any special hardware in this area should have minimum impact on cost of goods, board space utilization, etc.

#### 6.11 MASS STORAGE

The integrated disk storage capacity will be greater than 1.0M bytes at a minimum and 2.0M bytes if possible.

In addition to the integrated disk storage LISA will support larger capacity Winchester rigid disk storage in the 5m byte to 20m byte storage range. LISA will support connection of up to four of these drives to one controller. A low cost rigid disk back up device (e.g., Video Tape

Recorder or 3M cartridge) will be provided.

The disk controller interface and the low cost backup device must be integrated on one I/O module. A high volume, high speed back up device is essential in the office environment. This data must be backed up frequently and reliably. This is due to the valuable nature of company and employee (e.g, personal calendars, etc.) data that will be maintained on-line.

In the near future 5-1/4 inch Winchester technology will become available and cost effective. A future LISA model will provide the capability to replace one of the integrated mini-diskette drives with a 3m to 5m byte 5-1/4" Winchester drive.

## 6.12 TELECOMMUNICATIONS

LISA telecommunications capabilities are key to its success in the office marketplace (see section 12). LISA telecommunications facilities fall into five categories:

1. Telephone, voice, and modem
2. RS232 serial interface
3. Terminal emulation
4. Facsimile
5. High speed synchronous communications and high speed modem

The following sections will describe each of these facilities in more detail.

### 6.12.1 TELEPHONE, VOICE, & MODEM

LISA will provide a built-in modem for low speed asynchronous communications. The modem must support auto-answer and auto-dial (touchtone and pulse dialing). LISA will be supplied with a type approved DAA for connection to a modular phone jack. The DAA will provide a "T" connection to allow use of a normal telephone on the same circuit. The modem will share telephone control and line access with the user's telephone (e.g., like an extension phone in the home).

The built-in modem's serial electronics will be usable for connection and operation of RS232C compatible devices when the modem is not in use. This interface will support both asynchronous and synchronous communications.

LISA will provide the ability to digitize voice and to convert digitized voice back to analog signals. This capability must use a sample rate which is capable of reproducing telephone quality audio signals. The telephone handset microphone will be used to provide voice input for digitization.

The built-in speaker as well as the telephone handset speaker can be used to "play-back" the reconstructed voice signals (the telephone handset refers to the user's telephone connected to the DAA "T" connector).

#### 6.12.2 RS232C INTERFACE

LISA will provide a built-in RS232C serial interface in addition to the RS232C interface which is shared with the modem. This interface shall provide asynchronous communications at standard baud rates up to 19,200 baud. Full handshake capabilities must also be provided.

It is assumed this port can be used by the customer to connect printers with serial interfaces, acoustic couplers, phototypesetting equipment, and optical character recognition equipment (also see sections 12.4, 12.6, and 12.7).

#### 6.12.3 TERMINAL EMULATION

In medium to large companies it will be important for LISA to communicate with other host computers. This will require a variety of terminal emulation capabilities. It is important for LISA to be compatible with these existing systems and not require existing software to be modified to allow LISA-host communications.

Even in smaller companies LISA systems must interface with a variety of existing common carrier message services and electronic mail services (see section 12.6).

The following terminal emulation and communication protocols must be supported (in priority order):

1. Digital Equipment's VT100 or VT52 (asynchronous).
2. TWX & Telex
3. ITT electronic mail
4. IBM 3270 (Binary synchronous)
5. IBM 3780 (Binary synchronous)

It is assumed that the Digital VT100 emulation will meet most customer's asynchronous ASCII terminal requirements.

It is not clear at this time which of several bit-oriented protocols will become dominant in the next five years. The primary contenders are IBM's SNA and CCITT's X.25. This type of communications support is not required until 1983 so there is time to study the alternatives and watch the market.

#### 6.12.4 FACSIMILE

LISA must provide the ability to transmit to and receive data from digital facsimile machines such as the Xerox Digital FAX Transceiver. This communications will be possible through the LISA modem. Marketing will research the current facsimile market and vendors to determine the machines we will support (also see section 12.1).

#### 6.12.5 HIGH SPEED MODEM

LISA must provide an optional high speed modem which supports 2400 to 4800 baud, with binary synchronous communications. This modem will be a plug in board option and have its own approved DAA (see section 12 for various applications).

#### 6.13 NETWORKING

The use of more than one LISA in a single office environment creates the need for an inexpensive method of interconnecting LISAs together. The typical situation leading up to the need of a network will be as follows:

1. A user in a medium to large company will buy a LISA to solve a particular problem.
2. Other persons in the company will become exposed to LISA, want to learn more, get real excited, and finally get their own LISA.
3. As more individuals justify LISAs for their own use, they will want to share data files and possibly communicate with each other. This will be done by diskette sharing and shuffling and possibly telecommunications.
4. Company management will become aware of this new herd of equipment as users request more printing and disk capacity and a method of sharing these higher cost items. The ---- will really hit the fan at this point or management will support the use of LISAs fully and will want to install a local network.

This is not to say that all LISA network systems will be unplanned, ad hoc installations; some will be very carefully planned. Acceptance of networks of personalized computers will take time. This is due to the nature of the office (its basic resistance to change) and the time needed for management to comprehend the usefulness of the system. The important point of all this is that the modes of use of the network will typically be very simple so that cost effectiveness is more important than sophistication.

The LISA local network must provide the following:

1. Easy installation by electricians or building maintenance personnel for above ceiling installation and by office employees for surface installation and machine connect and disconnect.



2. Low cost per workstation connection - less than \$50.00 cost of goods per workstation.
3. Noise immunity from RFI/EMI such as electrical power tools, typewriters, etc.
4. Minimum length of at least 3000 feet without a repeater.
5. Support for up to 64 workstations on a single network.
6. Average effective data rate per user greater than 50,000 bytes per second.
7. Cable must be widely available through normal electrical products distribution and not cost more than \$0.75 retail per foot.
8. Installation methods, cable type, etc. must meet all building codes and safety regulations (e.g., OSHA, etc.) in the United States.

Within five years the data transfer capacity must be increased to handle image and voice data broadcast over the network. Capacity must be improved to 5m to 10M bits per second. This network would probably be much more sophisticated than the current envisioned Applenet. These ultimate goals will not effect design decisions today since many variables, which are not yet well understood, are involved. The focus for our first network product must be low cost, reliability, noise immunity, and ease of installation. A possible approach to the higher speed network might be to provide a Xerox Ethernet compatible network. This network product would be available in addition to the Applenet.

#### 6.14 PRINTERS

LISA must be able to produce a wide range of printed output including graphic images, high quality text, draft text for editing, camera ready copy, columnar reports, etc. This variety of printed output requires a number of output devices with varying speeds, quality, and dot densities. There are two major classes of printed output; graphics and text.

Text output refers to characters with limited variation on a single page such as letters, memos, reports, etc. In particular "text" refers to a lack of "graphics" or "dot" control. LISA will initially support two types of "text" printers:

1. High quality impact (e.g., daisy wheel) 30 to 80 characters per second.
2. High speed draft impact (e.g., matrix or band) 100 to 300 lines per minute.

Graphics output refers to the requirement to have arbitrary control over each "dot" that is printed or the ability to support a number of typestyles

(fonts) or line drawing. LISA will initially support two types of "graphics" printers:

1. Thermal dot matrix with arbitrary dot control (e.g., Silentype or HP-7310).
2. Non-thermal dot matrix with arbitrary dot control (e.g., ink jet or electrostatic ala Versatec).

In addition to the above four printers in the long-term support for other printing technologies must be available (see section 12.1, 12.2, and 12.7).

#### 6.15 GPIB INTERFACE CARD

LISA will provide an optional GPIB (or IEEE-488) plug-in interface board. This interface will support the IEEE-488-1978 interface standard. LISA will operate as a GPIB Controller and will support a maximum data transfer rate of 250,000 bytes per second. This rate will support the majority of GPIB devices currently available. The GPIB bus was originally designed to interface test and measurement equipment. Although this is not a major market thrust for LISA it is important to the OEMs who could benefit from application of LISA to GPIB environments. The GPIB interface in recent years has been gaining momentum as a "standard" interface for printers, magnetic tape systems, and even some photocomposition and microfilm equipment.

## 6.16 CONFIGURATIONS AND PRIORITIES

The following lists cover, in priority order, system components that will be provided with LISA.

The following items must be built into LISA at first release:

1. Display
2. Speaker
3. Keyboard
4. Pointing device and interface
5. Integrated disk drives
6. Modem and DAA
7. Modem's RS232 (Sync. & Async.)
8. Second RS232 (Async.)
9. Voice
10. External monitor jack
11. External audio jack

The following peripherals must be available for use with LISA at first release:

1. Letter quality impact printer
2. 5 MB or greater Winchester
3. Winchester back up device
4. Thermal printer
5. High speed impact printer
6. External minifloppies (Doublemint)
7. Applenet running internally at Apple

The following peripherals are desired at first release for use with LISA, and are REQUIRED within six months of introduction at the latest:

1. Applenet
2. Lower cost/higher capacity Winchester

3. High speed non-thermal dot printer
4. ECC memory module

The following items are not required for first release. See Section 13 for information regarding when they will be needed.

1. High speed modem
2. Color display option
3. 20 MB Winchester
4. High speed network (Ethernet?)
5. GPIB interface
6. External black and white monitor
7. IEEE floating point processor board
8. Power supply battery backup

## 6.17 SYSTEM SOFTWARE

### 6.17.1 OPERATING SYSTEM

The operating system will be simple and easy to use. There will be only one way to perform any function. Minimum skill level will be required to document, learn, and use the system, even for OEMs. As this development task is on the critical path, it is essential to take as few risks as possible in the implementation strategy.

The system will provide a simple approach for sharing resources through Applnet (The Datapoint Attached Resource Computer offers capabilities similar to those that are required). Public resources should be available at any time to anyone in the network with minimum performance overhead for one system. These resources will be shared by multiplexing and buffering a resource under the control of a single software program which is fully cognizant of sharing. (such as a File Server). This scheme will have a transaction-oriented nature so that, for example, two or three users can alternatively access and lock a record within a file, update the record, and unlock it. Private resources will be shared only by explicit actions and mutual cooperation of two humans at two machines.

The system will have a personal orientation: it must support a single user on a single machine. This single user may be performing multiple functions (e.g., printing a document, editing another, and waiting for network mail) thus multitasking must be supported. The operating system will provide limited security facilities due to this personal nature and the Public/Private resource concept.

File access and security will be provided, via a simple mechanism that is updateable. For files with extreme security requirements, encryption of file contents or network transmissions will be provided. Encryption can add overhead which may not be justified in many cases; these situations are satisfied by the file access system. It is recommended that an algorithm similar to the NBS system be used for encryption.

Additional requirements are: minimal development, maintenance, and documentation time and costs; uniform device-independent I/O interface; non-structured byte-stream files; hierarchical directory structure; removable private file systems; asynchronous interrupt handling; capability for handling dynamic storage allocation and cleanup; on-line floppy and public hard disk backup programs; and process to process communications.

All major applications will be capable of coexisting with the operating system and display memory on a 128K system. Notwithstanding the above, the operating system should be as compatible as possible with the Apple III operating system (a potential subset) and match industry standardization trends (i.e., UNIX).

### 6.17.2 SOFTWARE THEFT PROTECTION

The ability to protect software products (and ensure their profitability) from illicit copying or distribution is an essential and EXTREMELY IMPORTANT requirement of LISA software. This is a complex issue which requires immediate engineering attention and planning.

### 6.17.2 DEVELOPMENT TOOLS

Externally to Apple the LISA development tools will be an important tool for the OEM and the very sophisticated user. The following tools are required:

1. PASCAL compiler - a full PASCAL generating relocatable Motorola 68000 code modules.
2. Linker - create executable object modules from PASCAL relocatable modules.
3. Library - manage collections of relocatable modules.
4. Symbolic Debugger - provide debugging capabilities including the ability to reference memory locations by their symbolic names used at compile time.
5. Text Editor - provide a compatible editing environment with the Word Processor which allows easy editing of PASCAL source code.
6. COBOL compiler - (not required at introduction).

The PASCAL compiler should support Apple standard PASCAL. In addition independent compilation with full type checking must be supported. It would be advantageous to also support the UCSD extensions (e.g., strings, etc.).

The Linker and Library subsystems should be compatible with both assembler and PASCAL code (e.g., module formats, etc.). The object module format should also provide the necessary tables for use by the Symbolic Debugger.

It is assumed the LISA Word Processing text editor may be used for program preparation. If this is not possible another editor may be supplied, however, this editor must be a proper subset of the WP editor in that similar editing functions must be performed by identical keystrokes.

It must be easy to add user and OEM generated applications programs to the LISA Business Assistant shell. To meet this goal the LISA Business Assistant shell must be very modular and supplied with good interface documentation and library routines to ease the integration process.

These development tools must be available within 6 months of first shipments.

## 6.18 APPLICATIONS SOFTWARE

### 6.18.1 OBJECTIVES

#### 1. SELL SYSTEMS (HARDWARE AND SOFTWARE)

The primary objective for applications software is to help sell as many SYSTEMS as possible (hardware AND software) and make as much profit as possible (hardware AND software). Doing this will require both Apple software and outside software as discussed below.

#### 2. FOCUS 1980 APPLE RESOURCES ON INTEGRATED, HIGH-LEVEL "TOOLS"

Apple-managed software resources will provide a highly integrated, long-life, supportable, enhanceable set of products that will allow for significant and continued penetration of the major target market segment (the Office). The "Business Assistant", described below (Section 6.18.2) is the key to this approach. Initially it should put information processing power into the hands of the typical clerical worker. Ultimately, it should replace most of the need for conventional programming languages. These capabilities will allow Apple to build a strong and unique reputation in the office market segment.

#### 3. PROVIDE A SIMPLE, POWERFUL, UNIFORM USER INTERFACE

LISA must be fun to use. It will not be a system that is used by someone "because it is part of the job" or "because the boss told them to." For this reason, special attention must be paid to the friendliness of the user interaction and the subtleties that make using LISA rewarding and job enriching.

LISA will be designed to require extremely minimal user training and "handholding". The system will provide one standard method of interacting with a user in handling text, numbers, and graphics. Pointing devices, menu selection methods, and interaction with the screen will be used in standard ways across all applications. Command options presented to the user will be as intuitive and self-explanatory as possible.

The system will adhere to the concept of "gradual learning", since each user will start off as naive and inexperienced and become a relative "expert" within three months. A user must be able to do some important tasks easily and with minimal instruction or preparation (For example, it will be possible to create a business memo or letter with only 15 minutes of instruction, or create their first input form or report after just a few hours). The more sophisticated features will be unobtrusive until they are needed.

Errors will be handled consistently in as friendly a manner as possible, and the user will be protected from obvious errors (such as incorrect keystroke sequences and removal of diskettes at

inappropriate times). A generalized on-line "HELP" facility is not required (although this capability may be attractive as a future release option that utilizes a hard disk drive). The long-term goal is to provide state-of-the-art "interactive manuals" that can provide on-line instruction for LISA's software.

LISA will be easily activated with the touch of one switch (i.e., no additional initialization steps will be necessary to start an application). A "Set-Up" program will allow the user to customize several system attributes in order to "personalize" interaction with the system. This feature might cover features such as scrolling, cursor appearance, keyclick, margin bell, error handling, audio signals, display trimmings, user passwords, and so on. This capability will be as extensive as possible in order to make the system uniquely personal for the user without interfering with the interface standards noted above. A hard key should be provided that allows a user to put whatever he/she is doing on "hold" in order to answer the phone, look up an address, or respond to an asynchronous interrupt (time for a meeting, mail received on the network, etc.).

#### 4. THINK DOTS!

With a totally bit-mapped display system, LISA has an excellent opportunity to add function, flexibility, and greatly improve the traditional computer's human interface. We anticipate that the integral use of graphics will be a MAJOR reason why LISA is chosen by the customer over other machines.

The use of graphics will ultimately include business graphics; a graphics editor; facsimile input and output; multiple character fonts (including scientific symbols and the greek alphabet); proportional spacing; shrunken or enlarged views of forms, reports, and documents; LOGO generation; and customized cursors.

In addition, the use of graphics in general user interaction will set LISA apart from its competitors and will go a long way toward making the system friendly, easy and enjoyable to use. "Intuitive icons" can be designed to indicate certain messages to the user ("A picture is worth a thousand words"). A picture of a clock could indicate that it is time for your next meeting, or a drawing of a Western Union man could indicate that you have been sent a message by someone on the network. Different cursors can indicate different activities.

#### 5. USE OUTSIDE RESOURCES TO SELL HARDWARE

Although we would like to, we can't expect to immediately manage the development of a broad variety of excellent solutions for a broad variety of market segments. Therefore, in order to sell more systems, outside software development will be encouraged to help us sell hardware into those market segments that are not the major target. Included in this category are education, scientific, and industrial markets.



These additional products will provide customers with added value and capability even though the software is not as long-life, integrated, or supported as Apple managed and developed software. In some cases, this category of software may provide LISA with market segment experience and interim sales until Apple has sufficient management and development resources to mount a major attack on the market segment.

#### 6. DESIGN APPLICATIONS TO WORK WITH A STANDARD 128KB LISA

All applications developed by Apple will work with the minimum hardware configuration of 128K bytes of RAM and two minifloppy disk drives. Additional RAM memory will not be required except for increased performance. Additional mass storage will not be required except for handling larger data files (or for some networking applications involving access to a file server).

##### 6.18.2 OVERVIEW OF THE BUSINESS ASSISTANT

The Business Assistant is a software package for LISA providing an extensive set of simple, but powerful business tools capable of dramatically increasing managerial and clerical productivity in the office. It provides subsystems for word processing, data base management, forms creation, report generation, and graphics, as well as several smaller "personal" office applications such as keeping appointments and handling electronic mail.

Initially, the Business Assistant will focus on solving routine, information processing problems facing the typical office worker (particularly the secretary). Much of the user's interaction with information will be through business forms emulated on the screen and used for making queries and generating reports. Although users will be able to create and modify their own forms, the system will be provided with several examples which will constitute "mini-applications." Many of these will be grouped around the different forms and reports used by the various departments in an organization.

The Business Assistant, by focusing on routine secretarial information processing, will initially complement Apple III's emphasis on analytical problem-solving for managers. However, extensions to the Business Assistant should eventually replace the need for Apple III in general management applications. Ultimately, LISA is expected to replace most of the need for conventional business programming languages.

The major subsystems of the Business Assistant are outlined briefly below. Additional information will be provided in future software MRDs.

##### 6.18.3 VISICABINET

Successful implementation of the software plan hinges on the development of VisiCabinet. (Note: "VisiCabinet" is not a product name; it is simply Marketing's term for a system that would merge Visicalc entirely into the current "File Cabinet" concepts. It would be a generalized, integrated

system that provides a uniform method of creating forms, making queries into data files, generating reports, performing "Visicalc" electronic-blackboard style calculations, and ultimately replacing programming languages as the primary tool for the development of applications.)

VisiCabinet will combine Visicalc capabilities with a query processor, forms generator, and report generator. The rationale goes as follows:

1. The existing File Cabinet concept utilizes forms, reports, and queries against a data base. A logical extension of these features is the provision for allowing a field in a form or report to be "calculated" based on a formula using operations and possibly data from other fields.
2. Visicalc has only one form, which is essentially an "electronic blackboard". However, most users develop templates, or "forms", with defined fields and descriptions. Most fields in a Visicalc form are calculated based on a formula using operations and numbers from other fields. A logical extension of these features would allow a user to make a query against a data base from within a Visicalc form.
3. Theoretically, these two products are moving toward each other in capabilities, and Visicalc could be provided as a special "form" within the general concept of the File Cabinet. This would provide one tool of incredible power with only one straightforward user interface based on the concept of forms.

This product must meet the following objectives:

1. Provide extremely simple user-interface based on "forms" that appear on the screen just as they are in reality (i.e., black ink on white paper with shaded areas, as illustrated in Figure Five, a form printed by an H-P thermal printer). This interface will be the same for data and numbers and will provide a convenient and unified way to query, update, define, and control a data base.
2. Permit unsophisticated users to learn to do routine tasks with less than two hours of instruction.
3. Support "real" applications development within two years of introduction.
4. Easily permit custom reports and report modifications to be made by the user of a VisiCabinet-based application.
5. Allow casual query using the data maintained by an application.
6. Allow the easy creation of personalized "mini-applications" such as an address book or mail list by casual users at first release.
7. Provide full Apple III Visicalc features but be easier to use and fully integrated with query capability.

BUSINESS FORM PRINTED BY A THERMAL PRINTER

HEWLETT  PACKARD ***** SHEET NO. <b>2</b> OF <b>38</b>									
OPERATION DESCRIPTION									
PART NAME OBTAIN:	PART NUMBER	PRT REF	QTY REQ	ASY STA	INL TO LOC	ON PAGE NO.	STANDARD TIME		
							SU	RUN	
"X" Motor Assembly	07225-60120	A	1	1	10	3	1.00	.000	
Frame-Accelerometer Mount	07225-40040	B	2	1	10	3,5			
Elastomate-Short	T-32446	C	2	1	10	3,5			
Elastomate-Long	T-32447	D	2	1	10	3,5			
Transducer Assembly	07225-60020	E	2	1	10	3,5			
Cable Assembly - "X" Motor	07225-60010	F	1	1	10	3			
Stamp-"X" Mtr. Accelerometer	1600-0745	G	1	1	10	4			
Bumper "Y" Support	07225-40060	H	2	1	10	4			
Wire WH/YEL-W/Solder Lug	07225-60050	J	1	1	10	3			
"Y" Motor Assembly	07225-60121	K	1	1	30	5			
Cable Assembly - "Y" Motor	07225-60011	L	1	1	30	5			
Clamp "Y" Mtr. Accelerometer	1600-0746	M	1	1	30	6			
Plate-Pen Solenoid Mounting	07225-40043	N	1	1	30	5			
Solenoid-Pen Lift Assembly	07225-60042	P	1	1	30	6			
Wires WH/YEL-WH/RED	07225-60052	Q	1	1	30	5			
	07225-60051	Q	1	1	30	5			
"Y" Stator Assembly	07225-60006	R	1	1	50	7			
Support "Y" Cover Front	07225-40001	S	1	1	50	7			
Bumper Stop (Small)	07225-40015	T	1	1	50	7			
"Y" Arm Support	07225-20018	U	1	1	50	7			

			<b>ITEM</b>	OPERATION DESCRIPTION 7225 - ALL MODELS
			<b>BY</b>	BILL WIGAND
		6-13-79	<b>DATE</b>	
<b>REV</b>	<b>CHANGE</b>	<b>APPROVED</b>	<b>DATE</b>	<b>SUPERSEDES</b>
<b>REVISIONS</b>				<b>SPEC NO.</b> A-07225-90120-2

Figure Five

8. Contain data manipulation language with rich set of commands to permit a variety of queries that can obtain data from one or more relations.

9. Interface with all other Business Assistant subsystems at a very high level.

#### 6.18.4 WORD PROCESSOR

Most of marketing's requirements have already been incorporated into the design plans for the word processor and therefore will not be repeated.

The following items are the more important features that need to be provided (Some of these can be second release items):

1. "What you see is what you get" -- including pagination
2. Typing mode -- this feature would allow a user to type on the keyboard and have each keystroke printed immediately on a local printer. This would permit the typing of labels, envelopes, and short memos that are ordinarily difficult, or not done on word processors -- let's really try to make typewriter obsolete!
3. A first-time user will be able to prepare and print a business letter after only fifteen minutes of instruction
4. Multiple fonts
5. Use of graphics to improve user interface
6. Printer control from the keyboard
7. Print one document while editing another
8. Glossary/Abbreviations
9. Ability to automatically generate (from within the word processor) form letters and other documents incorporating data from a data base
10. Ability to create standard "fill-in" templates and forms
11. Proportional spacing on the display and printed
12. True wordwrap
13. Windows
14. Columns
15. Ruler/Quadding

16. Superscripts/subscripts
17. Table of contents/index generation
18. Automatic leader dots
19. Capability to detect misspellings
20. Ability to scan a document on the screen or hard copy highlighting the text that has changed since the last revision
21. Ability to incorporate graphics into text files
22. Footnotes, page-numbering, and formatting options

#### 6.18.5 GRAPHICS EDITOR

At first release, this product must be able to create simple lines, shapes, and grey scales to assist in forms creation and simple charts. As it evolves, the graphics editor will provide the same features, ease of use, and generality of the Xerox Alto "Draw", "Markup", "Smalltalk", and similar graphics programs (a sample of a Xerox Alto printout is shown in Figure Six). This capability will be used for more elaborate forms, organizational charts, diagrams, flow charts, figures, and simple drawing. The use of hard keys on the main keyboard for graphics editing should be "upward compatible" with the pointing device discussed in Section 6.9.

It should be possible to freely add graphics content to both forms and documents. On output, all subsystems should have a user-selectable printing parameter that specifies whether or not the printer is to print (1) graphics AND data content; or (2) just the data content. This allows users the choice, for example, of having preprinted forms or having a thermal or inkjet printer actually create the form on output.

#### 6.18.6 BUSINESS GRAPHICS

Business Graphics, similar in concept to the Apple Plot product, are required within six to nine months of introduction. This package will interface with data created by VisiCabinet, and allow output graphics to be mixed with text in documents, forms, and reports. A sample of this type of graph is shown in Figure Seven.

The following types of graphics will be required:

- o Pie charts
- o Bar graphs
- o Line graphs
- o Scatter charts
- o Polar coordinates
- o Log and semilog scaling
- o Three-dimensional cartesian coordinates
- o Three-dimensional perspective
- o Fitting of regression lines
- o Creation of growth-share matrices
- o Various grey scales and shading options

GRAPHICS GENERATED BY XEROX ALTO

(EXAMPLE OF MIXING TEXT AND GRAPHICS ON ONE PAGE)

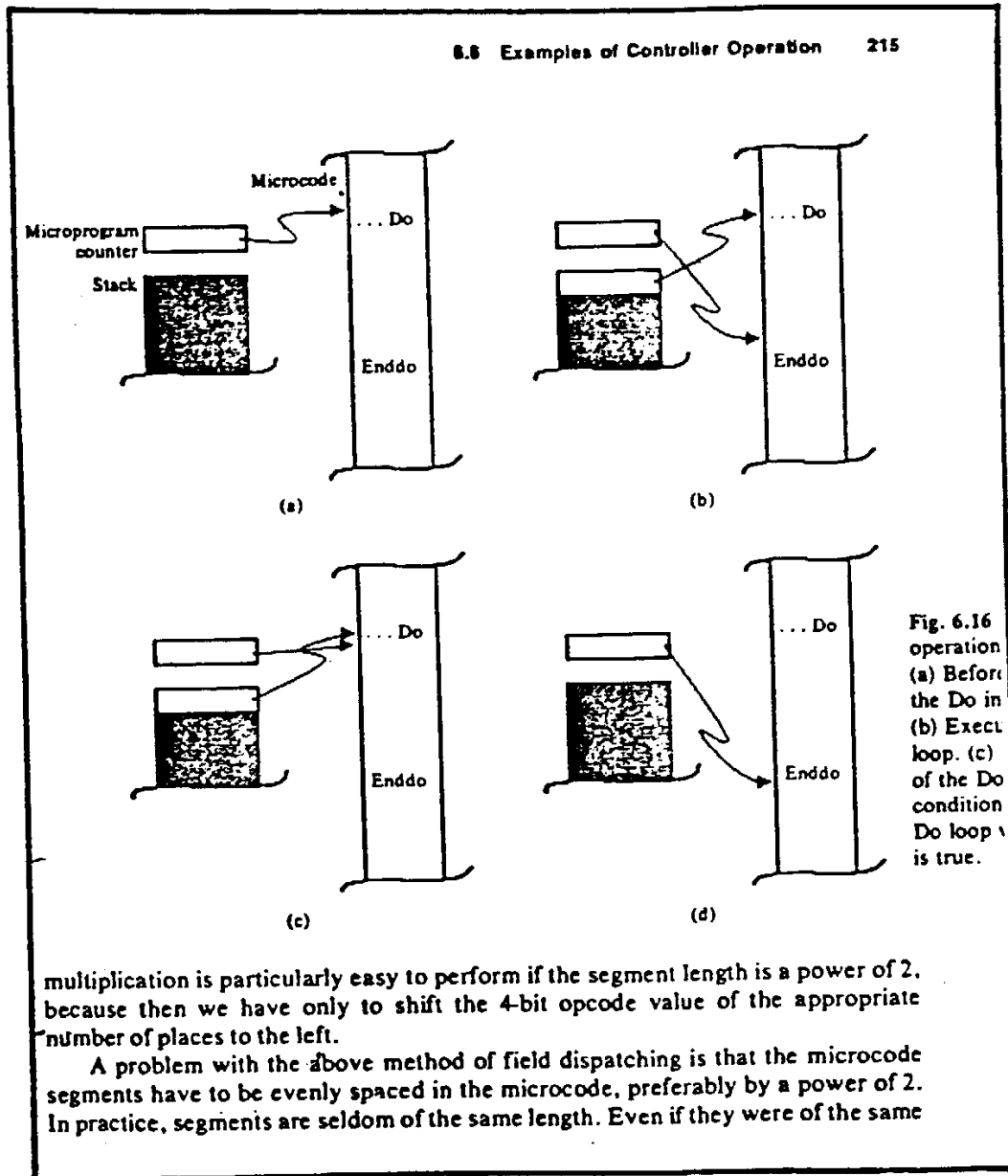

Figure Six

SAMPLE OF BUSINESS GRAPHICS

(EXAMPLE OF MIXING TEXT AND GRAPHICS ON ONE PAGE)

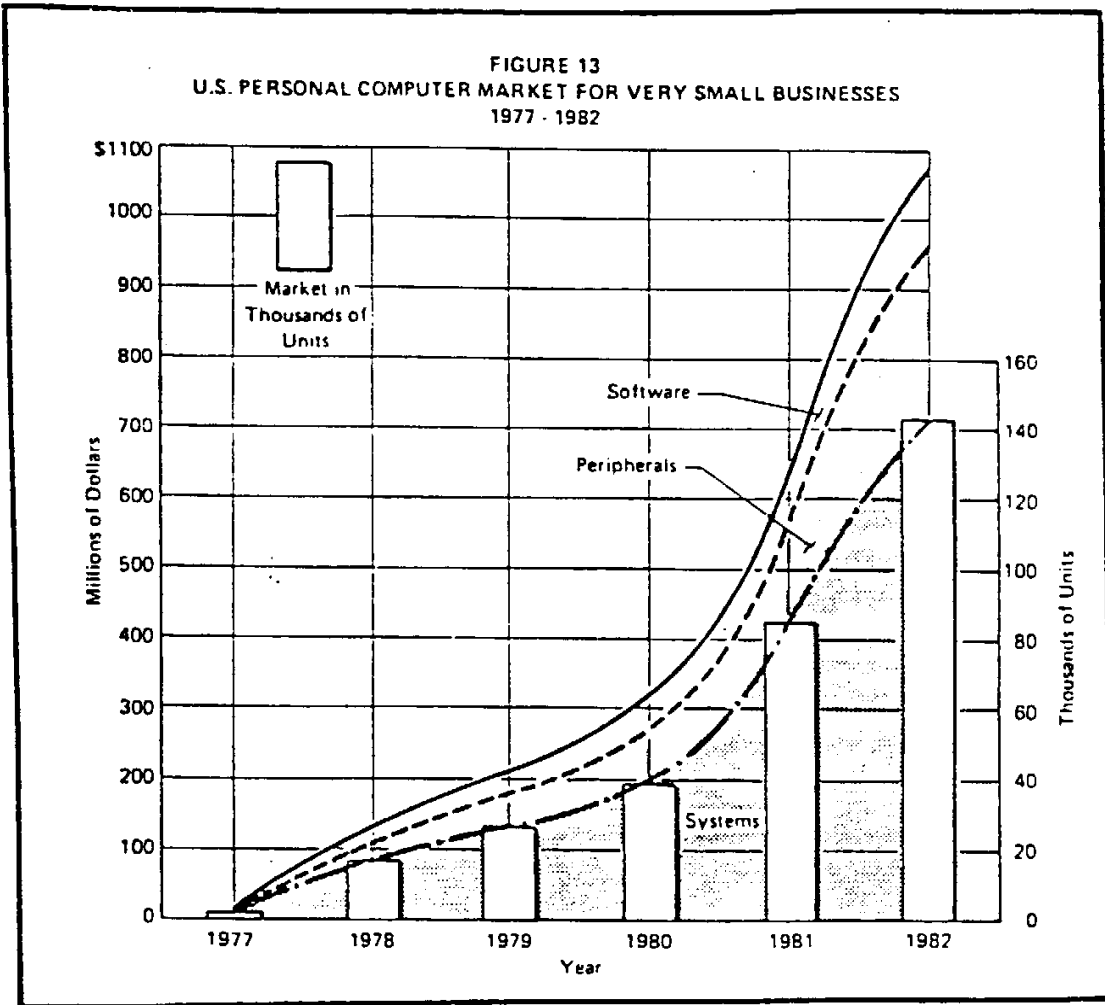

Figure Seven



### 6.18.7 PERSONAL APPLICATIONS

In addition to the mainstream subsystems, LISA will provide several "personal desktop" tools to enhance routine information processing in the office. The functions provided are as follows:

1. Calculator -- This module will have functions very similar to the TI 5040 electronic calculator. It will permit simple arithmetic functions and insert commas and decimals automatically into numbers. The system's speaker will be programmed to provide optional audio feedback. The display will emulate a strip of white calculator paper feeding upwards as if out of a calculator. Ultimately, the system will emulate, via softkeys, functions found on the various industry oriented calculators, such as finance, statistics, scientific, engineering, etc.
2. Directory and Auto Dialer -- When using the directory, the system will provide the user with a form that allows the user to select which field is to be searched. The generic search will find the desired choice or list the possible candidates. After the proper choice is made, dialing will occur, automatically determining whether to use touchtone or pulse dial. The system will have a redial option if the number dialed is busy or has no answer. The design will minimize keystrokes and provide for expansion capabilities to simulate the tone signals necessary to activate the PABX functions that can be found on a Dimension system.
3. Calendar/Appointment book -- A form will be used for the calendar scheduler that permits the user to see a day planner appear on the screen. The following entries will be made on the system just as you would in your dayplanner:
  - o The reason for the meeting
  - o Where the meeting will be held
  - o Who called it
  - o Classification (for billing)
  - o What preparation is necessary
  - o Any additional comments

The system will be able to provide audio or visual signals to remind the user of impending appointments. In addition, multiple alarms and a stopwatch will be available. Every month, the user would store a record of the previous month and print a report of the month's activities, which might eventually be tied to a client billing or time allocation application.

At the time networking becomes available, the system will be able to help schedule meetings for up to 20 people. This would occur by

accessing public files stored on the File Server. In order to maintain privacy, calendar information stored in this fashion would note only whether or not a particular time slot is open.

4. Tickler File/Note Pad -- The tickler file will allow the user to create and save "Things to do" lists, notes, and reminders. This function will be integrated with the calendar system so that appointments and meetings are automatically added to the tickler file. A simple mechanism for priority ranking will be provided.

5. Clock -- By depressing a softkey, the system will provide clock faces and/or digital displays showing times for New York, London, Tokyo, and Cupertino -- or any other locations selected by the user. The key attribute of this function is that it should be as user-definable and personalizable as possible.

6. In-basket/Out-basket -- This function will permit the sending of messages to other points via Applet, TWX, TELEX, FAX, or some other communication alternative. The receipt of messages on LISA will occur using the same communication channels. An icon will appear on the screen to inform the user that a message is waiting. Standard fill-in forms should be available (similar to memo pads) to assist in sending notes, mail, or route lists. These forms should cover TO, FROM, etc. but also various action options such as "for your information," "review and file," "read and return to me," "please reply and copy me," and so on.

#### 6.18.8 ACCOUNTING APPLICATIONS

As the File Cabinet (VisiCabinet) evolves, it will become an outstanding vehicle for the development of accounting applications. It will be more powerful and easier to learn to use than a programming language, and will be highly integrated with the other Business Assistant subsystems. During 1981, marketing will define requirements for the following applications to be developed in 1982 and beyond:

1. Client/Time Billing
2. Inventory Management
3. Order Entry/Purchasing
4. Billing/Accounts Receivable/POS Processing
5. Accounts Payable
6. General Ledger
7. Medical Forms and Billing
8. Payroll

#### 6.18.9 .OUTSIDE SOFTWARE DEVELOPMENT

Outside software can give us an opportunity to sell into secondary markets without a great deal of effort. Five primary methods will be used to encourage this process:

1. Bootstrap (i.e., steal!) as much as possible off software that has been developed for Apple III
2. Freely acquire or contract for additional software
3. Provide a "Catalogue" type vehicle for positioning and distribution of this "second class" software
4. Encourage software houses to independently develop and market applications for these specific market areas
5. Actively solicit and encourage OEMs who are interested in the secondary markets

For LISA, these low priority markets and some appropriate catalogue products are:

1. Scientific and Industrial
  - o FORTRAN Compiler
  - o Instrument control software
  - o Apple III stat/science algorithms
  - o Real Time Operating System
2. Education
  - o Apple III Pascal (may be able to ship this well before the 68000 compiler is a "product")
  - o PILOT
  - o BASIC Interpreter
3. Analytical Professionals (secondary market through 1982)
  - o Apple III math/stat algorithms
  - o Apple III Visicalc
4. Business Accounting (secondary market through 1981)
  - o Apple III Pascal-based "Controller II"
  - o COBOL Compiler

Whatever "catalogue" software is acquired must pass inspection within the Software Acquisition group, but need not meet Apple standards as far as the user interface and documentation are concerned.

In most cases, this software provides added functions for LISA owners who cannot "wait until 1983 to run their general ledger." In some cases, we will deliberately obsolete catalogue products with our own offerings; in other cases (e.g., COBOL) acquired software may be upgraded by Apple to provide a greater degree of integration with the LISA system.

#### 6.19 COMPATIBILITY

Due to the inevitable coexistence of Apple III's and LISAs in dealerships, OEMs, and office networks, it is highly attractive to have as much compatibility as is practical given the other functional objectives for the product line. At a minimum, the two product lines should share a common set of data types (and ultimately, a common arithmetic package conforming to IEEE floating point standards), provide file conversion utilities, and support both Appenet and a compatible Pascal. In addition, it is extremely attractive to have common files and access methods. Any additional compatibility is highly attractive INsofar AS IT DOES NOT REQUIRE THE PROVISIONS OF SUBOPTIMAL APPLE III FEATURES ON LISA, OR SERIOUSLY HINDER LISA FROM ACHIEVING ITS OTHER FUNCTIONAL OBJECTIVES. In any case, there should be no differences between the two products that are not directly attributable to critical market needs for more capability.

## 7 PUBLICATIONS

The long-term goal for publications is to provide state-of-the-art "interactive manuals" that can provide on-line instruction for LISA software.

The manuals should be easy to use and informative so that on-site training is not required and support requirements are kept to a minimum.

The absolutely essential manuals necessary for product introduction are as follows:

1. Owner's Manual -- provides information on installation, operation, and maintenance of the system.
2. Word Processor Manual
3. Problem Analysis Guide -- this guide should provide the user with information on use of the diagnostics diskette and procedures that should be followed to determine which modules of a malfunctioning system are failing (see section 9.3 on system diagnosis).

This minimum set of manuals will make LISA "shippable".

Completion of the following manuals are expected to coincide with the introduction of the respective software products:

1. Business Assistant Introductory Guide -- describes the integrated nature and component parts of the Business Assistant and provides information and examples of the creation of forms, output reports, and query by example.
2. Operating System Reference Manual
3. Pascal Reference Manual
4. Reference Manuals for various peripherals

The development of all these manuals should occur in parallel with the development of the software. The manuals should be extensively Beta tested to insure that both the system and manuals can be used to train the uninitiated customer.

The use of interactive manuals is encouraged for all tutorial manuals (Business Assistant, Word Processor, File Cabinet, etc.), however, the development of all of them is not required at first release. The interactive manuals should take advantage of LISA's graphics to provide a friendly and easy way to learn about LISA.

In its simplest form, an interactive manual should provide menus with alternative manuals from which to choose. By following the menus, the user would arrive at the specific area of interest. The system should be able to ascertain the users' level of experience and present the appropriate level of explanation. The interactive manual should also provide query

and/or key word search capabilities for quick reference.

There will be one interactive manual provided at introduction which will introduce the user to LISA, complete it's installation, and teach the user use of the pointing device and other important facets of the user interface. In particular this manual will teach:

1. SET-UP procedure and features
2. How to use the pointing device
3. User interface features, use of windows, the cursor, etc.
4. Desktop tools concepts
5. Examples of system use
6. Diagnostics and service procedures
7. Description of other features

## 8 MANUFACTURING

LISA will be a high volume (greater than 20,000 units per year) product. The usual precautions to insure ease of production, testing, and procurement should be followed.

Components must be truly second sourced and in current production at the time of design (except the Motorola 68000 microprocessor). Components must be qualified before use in designs to insure vendor's ability to supply required quantities (especially ROMs and RAMs).

The marketing forecast (see Product Contributions and Table 1) indicates the required manufacturing volume ramp during the first 2 years of production.

It is essential that the LISA manufacturing and documentation package be very clean and "self-contained" to allow relocation of manufacturing or easy start-up of remote manufacturing facilities.

Ample test points must be provided to allow complete functional testing and nodal testing sufficient to isolate single I.C. failures by relatively unskilled production technicians.

Systems should be checked prior to shipment to minimize the time that the sales outlet must spend readying systems. Currently for the Apple II, 33% of the systems received at the dealer locations are dead-on-arrival. The reason for these inoperable systems is split evenly between missing parts, loose connections, and malfunctioning components. The dealer time spent on readying systems is excessive and therefore adequate testing and burn-in should be done to minimize the number of LISAs which are D.O.A.



## 9 SERVICE/SUPPORT REQUIREMENTS

### 9.1 HOTLINE

Lisa should be designed so that on-site support people are not required and that a suitably staffed hotline is sufficient.

### 9.2 INSTALLATION

The system will be designed to be installed by the user, without any tools. I/O modules should be installable with a screw driver as the only required tool.

### 9.3 DIAGNOSIS

Included with the system will be diagnostic software and a Problem Analysis Guide (The combination of which will be referred to as PAG) that the user can follow to determine the cause of a system malfunction. This guide will be packaged with LISA and be easily followed by the uninitiated. Following the PAG will not only insure that there is a legitimate system problem, but will indicate which Field Replaceable Unit (FRUIT) is failing. The guide should be self-explanatory and not require any additional training. Questions regarding its use should be handled by the Level 1 Service Center.

In addition, the system will be designed so that a non-technical person can, using the PAG, replace a FRUIT in the field, with only the use of a screwdriver (i.e. no probe, scope, soldering iron should be necessary). This non-technical person might be a key person at the account who has spare modules in inventory, or a delivery person from the local outlet who carries an entire FRUIT inventory. Regardless of who replaces the FRUIT it should be simple and the training necessary for becoming a Level 1 Service Center should take no more than one half day. Level 1 Service Centers should maintain sufficient parts inventory to provide same-day service in most cases.

### 9.4 SERVICE DESIGN

The design for LISA should minimize failures and permit the user to easily service the machine. Servicing the system should be friendly, safe, and simple. 80% to 90% of the system failures should be serviced by using the PAG and having the failing FRUIT replaced. The MTTR (Mean Time To Repair) should be one-half hour (it should take no more than 15 minutes to diagnose the failing FRUIT and no more than 15 minutes to replace it) and the MTBF (Mean Time Between Failures) should be two years.

The spare parts kit that the Level 1 Service Center carries should include a complete set of FRUITs and duplicates of those FRUITs which have a high likelihood of failure (based on Engineering's analysis and projections).

The other 10% to 20% of failures will require that the entire unit be replaced by the local Level 1 Service Center.

The system should have a modular design with all modules being less than 15 pounds except for the shell that houses the CRT and system components. This will allow most people the ability to replace a FRUIT with little difficulty, and while the CRT module is heavier, it should have the lowest failure rate.

A service cost goal of 5% per year of the retail price is desired, assuming this is profitable.

#### 9.5 LEVEL 2 SERVICE

The Level 2 Service Center is responsible for servicing any FRUIT or system that the Level 1 Service Center cannot repair. Turnaround time on repairs must be fast enough to help support the goal of same-day-service by the Level 1 Service Center.

For all system failures that could not be diagnosed using the PAG because it was an intermittent or a combined hardware/software problem, a functioning system should be returned to the Level 1 Service Center and the malfunctioning system should be analyzed, with the findings documented and distributed to all service centers.

## 10 SALES AND DISTRIBUTION

While the current distribution channels have penetrated the business market with Apple II's, it is unclear that individuals in medium to large size corporations will go to our retail stores to buy a \$5,000 LISA on their own. In most cases, the company will be buying the system and that will more than likely require a visit from a salesman to get the sale. In fact, only 19% of current Apple II business users work in corporations that employ more than 100 people.

It is because of this concern that other methods of distribution are under consideration. While distribution channels will be developed for Apple III to reach the office and professional markets, and LISA will use and benefit from these channels, there continues to be an examination of how best to approach small, medium and large corporations. A variety of methods are being evaluated based on the following distribution objectives:

1. Develop channels that will allow Apple to meet sales and profit objectives
2. Insure a high degree of control over the point of purchase
3. Establish a high quality and professional service and support capability
4. Permit for rapid expansion
5. Keep sales costs low

Regardless of the type of distribution channel that is used for LISA, it is imperative that the sales outlet provide space for the following:

1. Demonstrations
2. Seminars
3. Service
4. Training
5. Displays
6. Salespeople
7. Closing rooms

The facility should provide an ambiance of professionalism through the interior design, the dress of the employees, the service they receive in the store, and the type of applications it carries.

The facility can't try to be all things to all people. IT SHOULD ONLY BE A PLACE FOR BUSINESS PEOPLE TO GO TO RECEIVE EXPERT ADVICE ON OFFICE APPLICATIONS AND HARDWARE.

While we are planning in advance what the distribution channel requirements are, we can't establish the distribution channel until we have a product. To date, it appears that there are several ways to sell LISAs. The following APPEARS to be the BEST method of reaching these markets, however, market research is planned to confirm or change these beliefs:

**MEDIUM SIZE COMPANIES** — This group will best be reached by outlets who maintain the "spirit of retailing" (i.e., very low sales cost and no cold calls), and have facilities for seminars and private demonstrations. Customers are brought in through advertised seminars and by salesmen who call on qualified leads in the field.

**FORTUNE 1500** — While this group will have similar requirements to the medium size companies, the most probable method of approaching it will be a KEY ACCOUNT sales program. This group of high level salesmen will call on the highest levels of an organization and work on large purchase orders. These salesmen will attempt to get commitments for certain volumes and configurations. For the company, an Apple Corporate Buy Program is one way that an organization can attempt to maintain control and standardization over the buying habits of its many employees. A likely interim strategy would be to arrange for a key OEM to sell to the top 1500 named accounts. This approach may be necessary to boost sales until a captive key account sales force can be set up. Prominent candidates are firms like Kodak, 3M, Xerox, A. B. Dick, and Moore Business Systems.

**SMALL SIZE COMPANIES** — The smaller firms will probably best be served by the top 35% of our existing dealers, whose professionalism and business orientation is improving.

## 11 INTERNATIONAL MARKETING ISSUES

We anticipate 40-50% of our sales to be overseas. To sell to each of these countries, LISA must satisfy the unique requirements of each country. These specific requirements still need to be determined for each country and fall into the following categories:

1. Character set/keyboard— The system should insure that any foreign keyboard (i.e. key caps are foreign) with the appropriate software character set, can run on any LISA without any hardware modifications (i.e. keyboards should be completely exchangeable, be independent of the hardware, and be software driven). This will insure that providing the proper keyboard and character set software is sufficient to meet each country's needs. LISA's bit map display should allow the flexibility, after determining the best character set, designing the keyboard, and properly capping the keys, to produce output on the screen for ANY language.
2. Communications requirements— In many countries, a license is required for modems. An examination is necessary to determine a) what are the standards, b) how difficult are they to meet, and c) whether an integrated modem that does not meet the standards has to be removed or just be made inaccessible.
3. Translation of manuals/softkeys/displays is needed.
4. The communication input medium between LISA and the user should be able to perform its function in the user's language
5. The communication output medium between LISA and the user should be able to perform its function in the user's language
6. Power/Electrical compatability-- Besides the obvious 100V, 110V, and 220V power requirements, there is the additional concern regarding whether the machine can be plugged into the country's wall outlet. The power cord needs to be checked against local specifications, color codes, and required approvals.

The priority, by language, for which to provide compatibility is determined by the ease of conversion and the potential market size. The development of LISA for these countries should not impact the scheduled introduction in the U.S. The planned introduction in the U.K., Germany, and France should occur within six months of the domestic introduction, with Japan occurring within 12 months. What follows are the languages in order of priority:

1. English- While the character set is easily modified to U.K. standards by the addition of the Pound sign, the other questions still remain.
2. German
3. French- In the French language, each of the vowels can be

accented with one of three different overstrike symbols. In France they are used to creating accented characters by means of an overstrike. What needs to be examined is the feasibility of this vs. developing special character keys on the keyboard for these symbols.

4. Japanese- Known requirements are:

- o Kata Kana keyboard with some additional Kanji symbols (yet to be determined)
- o 100V + or - 10%
- o 1 year warranty
- o Licensing of modems
- o 2 prong power cord plug

5. Chinese

6. Swedish

7. Italian

8. Spanish

9. Dutch/Flemish

10. Arabic

11. Russian

12. Greek

## 12 LONG-TERM PRODUCT AND MARKET OVERVIEW

It is anticipated that within two years after initial release the product line will be augmented with at least two new models. One model would simply be a cost-reduction aimed at eventually offering the same LISA features for roughly half the original cost. A potential variation would allow one floppy disk to be replaced by a 5 megabyte 5" Winchester disk or two megabytes of bubble memory.

The second major new model would involve repackaging the unit so as to allow for a full page display and to split the disk drives off so they could be treated as an option. Then a special keyboard will be provided so that executives, for example, could just have the display with electronics and a "command console" keypad, also at lower cost. An additional package will be required eventually for the File Server (shared hard disk facility). Initially, the need for this product can be met by dedicating an actual LISA to controlling access to a hard disk. Eventually, however, it may be attractive and cost effective to package the hard disk, backup device, and LISA electronics into one box.

### 12.1 TECHNOLOGY OUTLOOK

If LISA is to become the office system of the 80's several technologies must be accessible to the LISA user. In particular:

1. Facsimile
2. Xerographic laser printing
3. Ink-jet printing
4. Microfilm or microfiche
5. Optical Character Readers
6. Private Automatic Branch Exchange (PABX)
7. Photocomposers

Figure Eight is an illustration of how these different pieces of equipment interrelate to each other in the office environment. Figure Eight also illustrates the primary information handling functions of the office:

1. Input (I)
2. Processing (P)
3. Storage (S)
4. Output (O)
5. Distribution (D)

FUTURE OFFICE TECHNOLOGIES

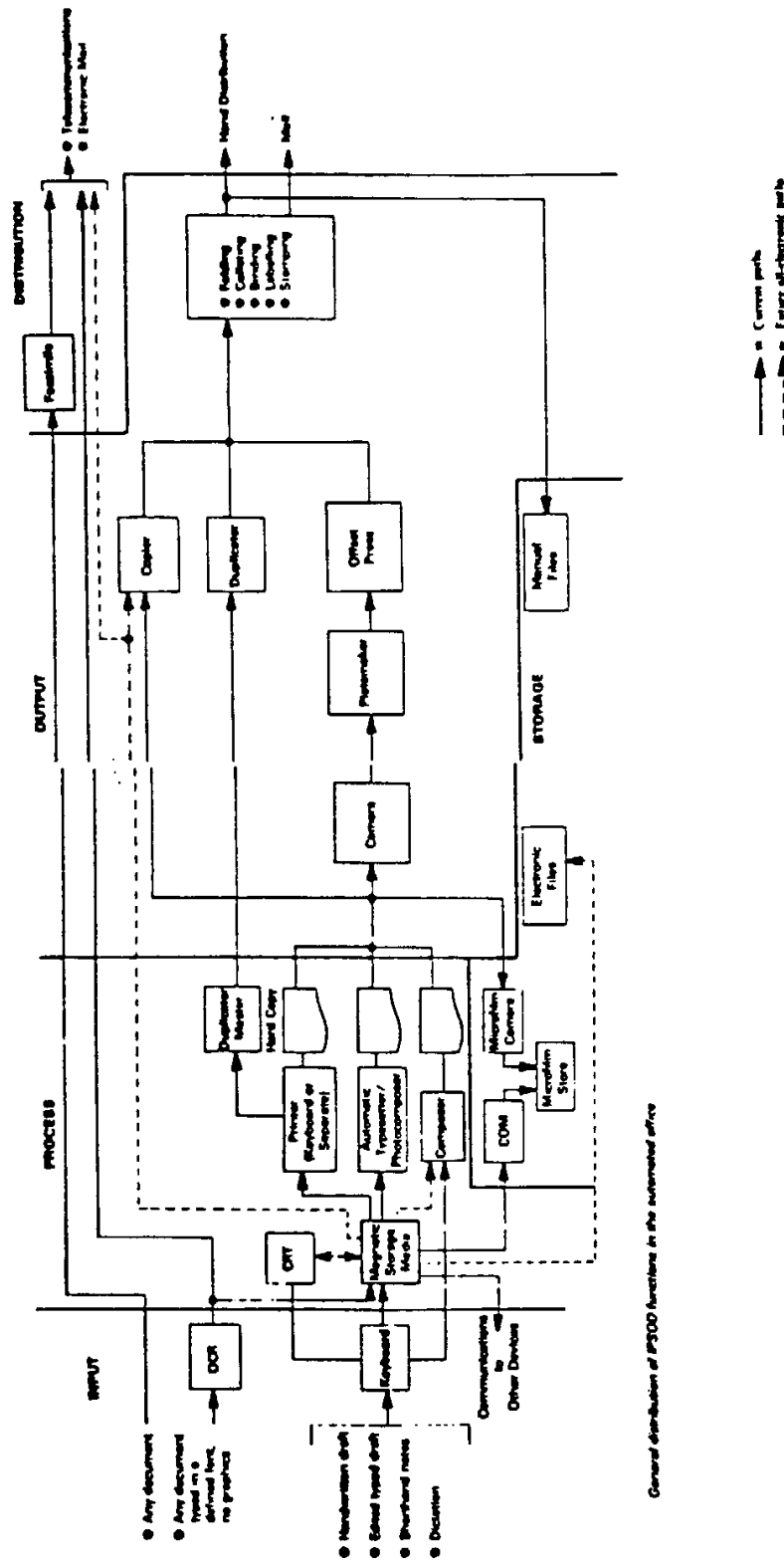

Figure Eight



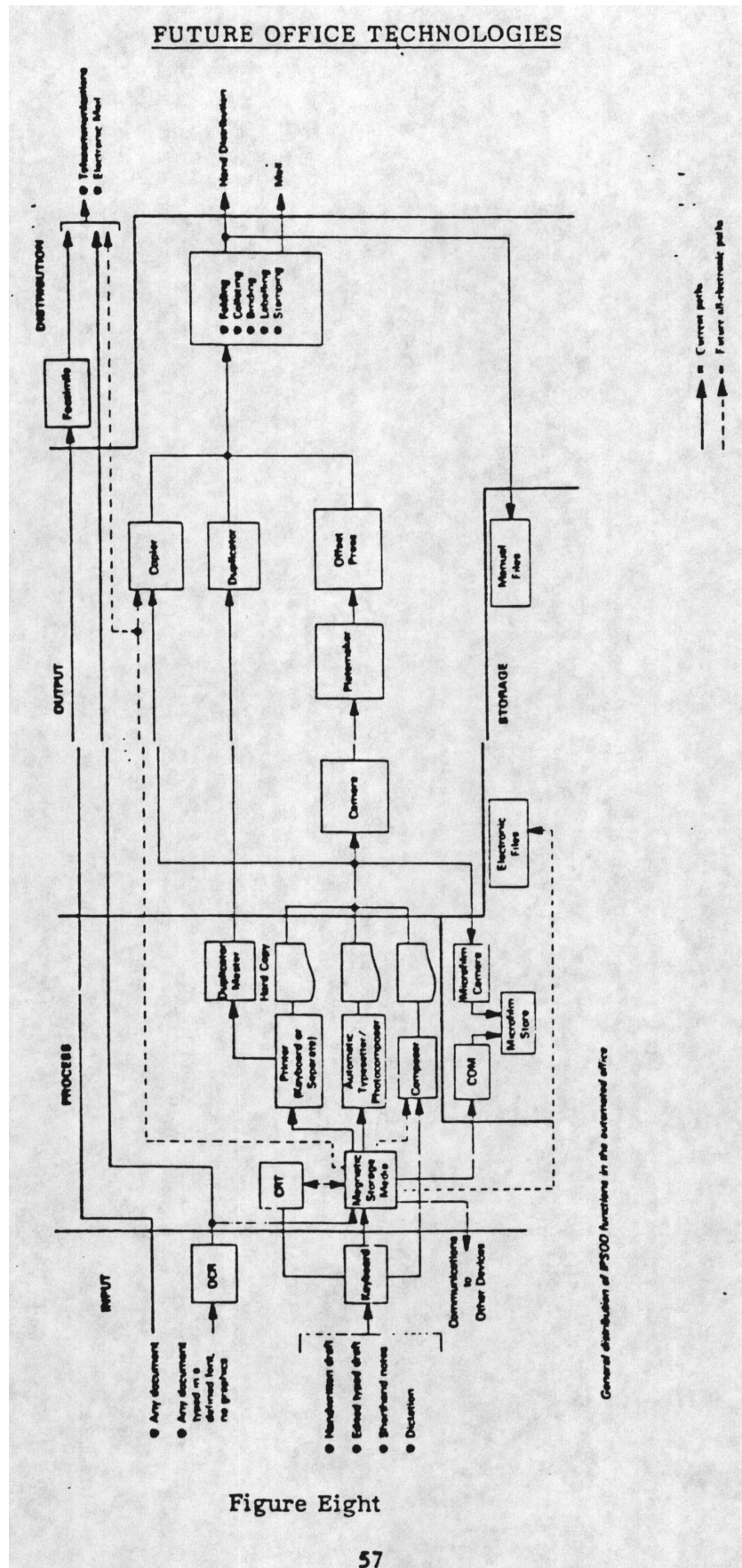

Figure Eight

We would like to kill a myth which appears in much of the literature on the office of the future. The common model is a highly integrated set of facilities with no duplicate functional mediums (e.g., Fax replaced by electronic mail). There are two problems with this view. First, transition takes a great deal of time and the variety of devices and techniques will be here for a while. This is especially motivated by suppliers who want to stay in business! Second, the range of services required are so broad that no one supplier could provide them all (not even IBM, yet).

What the office of the future will be during the 1980's is a collection of office equipment which can COMMUNICATE! Our flexibility in creating software and hardware to communicate with the various devices will determine our ultimate success.

Table Two may better relate the technologies which will effect LISA in the office environment.

The LISA system must provide "hooks" into each of the five office functions (IPSOD) and to each of the above technologies to be truly useful. The following paragraphs will attempt to briefly describe supporting technologies of LISA (or, maybe technologies supported by LISA!).

## 12.2 FACSIMILE

Facsimile is actually a very old technology which has enjoyed a new burst of application in the 1970's. Facsimile machines provide a very inexpensive means of transferring graphics and text information over a phone line. LISA must be able to take advantage of facsimile as an inexpensive remote printing device with text and graphics capability. LISA should also be able to accept input from a facsimile machine; digitize it, store it, display it on request, and retransmit it. It is not expected that facsimile will be used as a data capture device for text due to the problems of pattern recognition, however, we should be prepared to supply this function within five years.

## 12.3 PRINTING

In addition to conventional printing technologies (e.g., matrix, daisy wheel impact, and thermal) several new printing technologies must be accessible to the LISA user. It is not clear in the long run which of two printing technologies; xerographic laser printing and ink jet, will become dominant in the late 1980's. Xerographic techniques offer high speed and can be integrated with the standard dry paper office copier. Ink jet provides a lower cost, lower speed and the print quality can be better than xerography.

There are several electronic xerographic printers on the market today; Xerox 1200 and 9700, IBM 6670 and 3800, as well as several lower cost units from Canon and Japan Inc. At least three major laser printer announcements

FUTURE OFFICE TECHNOLOGIES

<u>Device</u>	<u>I</u>	<u>P</u>	<u>S</u>	<u>O</u>	<u>D</u>	<u>Availability</u>
Facsimile	X			X	X	1981
Xerographic Laser Printer				X	X	1983
Ink Jet Printer				X		1983
Microfilm			X			1983
Optical Character Reader	X					1984
Personal Telephone	X				X	1981
Telephone Switching & PABX					X	1984
Photocomposer				X		1982
Magnetic Disc			X			1980
Conventional Printer				X		1980
Video Tape Recorder		X				1980
TWX & Telex & Mailgram	X				X	1980
Incremental Plotter				X		1981
LISA		X				1980

Table Two

are expected this year. The LISA system must be capable of creating data in formats compatible with these printers and be capable of transmitting data directly to these printers. As this market matures it will be easy to identify one or two suppliers which we must be compatible with. All the systems available today provide a high speed synchronous communications interface supporting IBM Bi-sync. protocol. The Xerox Ethernet and IBM's SNA loop will become primary contenders for equipment connection in the next five years. These laser printers have full graphics and multiple-font capabilities that make a LISA product exciting in the office!

The most significant ink jet printer on the market today is the IBM 6640. This printer provides relatively high speed multiple-font text that competes with a Selectric. This printer is accessible via a synchronous line using IBM Bi-sync. communications. It is not currently clear if and how we should support this device. IBM has developed a common language for communicating with its 6670, 6640 and daisy wheel printers. This "language" consists of embedded commands in text files which direct the operation of printers (e.g., font change, pitch change, print-time margins, etc.). It appears critical that the LISA Word Processor and Report Generator explicitly or implicitly support this command structure since it is rapidly becoming a "standard".

It is advisable for the long term success of LISA that Apple be able to offer a proprietary ink jet or xerographic laser printer.

#### 12.4 MICROFILM

Microfilm and microfiche will become very important in the 1980's as a powerful data storage medium for computers. The majority of business documents must be saved for relatively long periods of time. Microfilm is a natural medium for this since it is permanent and if the proper format and character set is used can be read by both humans and computers. At present there are several devices on the market which provide automated retrieval and printing of large microfilm files.

The exact relationship between microfilm and LISA is not clear at this time but it is safe to say that within five years we must be able to communicate with microfilm equipment from Kodak and other vendors. The first step will be to interface to Computer Output on Microfilm or COM printing systems. The second step will be to interface to microfilm retrieval and storage systems. Here we would request a document, digitize it, and display the document on LISA. The document might be edited to produce a new document, text may be extracted, or an entire year of documents might be scanned to produce a historical reprot of business activity. Once again most COM systems provide a synchronous interface using IBM's Bi-sync.

#### 12.5 OCR

Optical Character Recognition devices transform typed documents into ASCII via optical scanning and pattern recognition. Most OCR systems require text to be typed on a Selectric typewriter with very strict margin and

format requirements. Even with these restrictions OCR is becoming widely used in offices which have a centralized WP facility. Most OCR devices transmit asynchronous ASCII over RS232 or current loop. OCR essentially turns every Selectric typewriter into an input device. In the larger companies this is an important facility which we must support on LISA. IBM's text processing command language is also supported on their OCR readers. We do not need to offer our own OCR device but significant cost reductions are possible over available units. This is an important offering to the large company.

#### 12.6 TELEPHONES & PABX

An entire document could be written on recent advances and opportunities in the PABX area, and marketing will hopefully write the document soon! Even in small companies (greater than 30 employees) some form of PABX is essential. Datapoint is currently the leader in integrating "personalized computers" and the telephone. Their Integrated Electronic Office is an excellent example of the possibilities. Within five years (probably three) LISA must offer the ability to completely replace the desk telephone on desks which have LISAs and must be able to control the phones on desks which do not have LISAs. Apple must plan its activity in this area carefully since we do not want to replace too much of the phone system. The service and regulation responsibilities are large.

We should be able to fully integrate the telephone handset and dialer into LISA. We should also provide interfaces to private switching equipment for call recording, call routing, and other services similar to the Bell System's Dimension system.

#### 12.7 TWX, TELEX, & ELECTRONIC MAIL

Three services which are closely related to the phone are Telex, TWX, and Mailgram. LISA must be able to access all three services to transmit and receive "electronic mail" (a new name for a service originally provided in the late 1800's by Western Union!). This will require special software to simulate protocols and some special hardware (e.g., current loop line interfaces). In the larger companies with networked LISAs we can completely replace TWX, Telex, and other such equipment. In the smaller company we could replace such equipment but this implies special software and reliability features (you can't miss a TWX message). Several other major vendors are offering electronic mail systems including ITT and soon the phone companies. We must interface to these services.

#### 12.8 PHOTOTYPESETTING

Photocomposers are devices which transform digital text into camera ready copy suitable for input to one of many printing processes. A variety of machines and internal techniques are available although most machines present a simple interface to the outside world (usually RS232 or 8-bit parallel). The demand for typeset quality printed material even for one

page office documents is increasing dramatically. The cost of photocomposition equipment has been dropping steadily but very slowly in the past 10 years. The advent of high quality ink jet and laser xerography will force prices to drop substantially in the next five years.

It is important that documents produced by LISA including text, reports, and forms can be submitted to a photocomposer. Most photocomposers use a simple scheme of embedded commands in the text to control formatting, font, and other printing parameters. Unfortunately there are few standards but the task is simple. Marketing must further study this area to determine the appropriate devices to support.

### 13 PRODUCT LINE TIMETABLE

Product introductions have been grouped into four time periods:

1. Introduction ("first release")
2. Within 6 months of introduction
3. Within 12 months of introduction
4. One year from introduction and beyond

It is assumed that introduction will occur sometime in the first quarter of 1981.

Also please note that this is a list of PRODUCTS that must be documented, tested, and be sold to customers. The list does not consider how quickly these items need to be available for internal use.

The following products are required for introduction:

1. Minimum LISA hardware configuration
2. Pointing device
3. Letter quality printer
4. Winchester disk
5. Winchester back up device
6. Thermal dot matrix printer
7. High speed impact printer
8. External minifloppies
9. Applenet running internally at Apple
10. Asynchronous Terminal Emulator
11. VISICABINET release I
12. Word Processor release I
13. Basic Calculator
14. Directory/Auto dialer
15. Calendar/Appointment book
16. Tickler/Note pad/Clock

63

17. Graphics Editor release I
18. Appropriate manuals and introductory interactive manual

The following products must be provided within six months of introduction:

1. Applenet
2. Lower cost-higher density Winchester
3. High speed non-thermal dot printer
4. ECC Memory module option
5. TWX/TELEX
6. Facsimile support
7. Operating system
8. Program development tools
9. VISICABINET release II
10. Word Processor release II
11. Business graphics
12. Network meeting scheduler
13. IN/OUT basket
14. All appropriate manuals

The following products should be provided within one year of introduction:

1. High speed modem
2. Color display option
3. 20MB Winchester
4. Integrated Winchester 5-1/4"
5. ITT Electronic mail
6. IBM 3270 Emulation
7. VISICABINET release III
8. Word Processor release III
9. Graphics Editor release II



10. Extended Calculator algorithms
11. COBOL
12. FORTRAN
13. BASIC
14. Catalogue products (see 6.18.4)
15. All appropriate manuals

The following products do not need to be provided until one year or more after introduction:

1. External black & white monitor
2. Full page display LISA
3. Executive keyboard
4. IBM 3780 Emulation
5. Bit protocol support
6. High speed network (Ethernet?)
7. GPIB interface
8. Client time billing
9. Inventory
10. Order Entry
11. Purchasing
12. Billing, A/R, POS
13. A/P
14. G/L
15. Medical forms and billing
16. Payroll
17. Japanese keyboard
18. Xerographic laser printing
19. COM support

20. OCR support
21. Phototypesetter support
22. File server package
23. IEEE floating point processor board
24. Power supply battery backup

66

14 COMPETITIVE PRODUCTS

The following profiles are of known products that offer capabilities that are similar to those of LISA. Specifically, each of the following small systems offer either (1) both word and data processing, or (2) electronic mail or other "integrated office" capabilities. The products discussed range from inexpensive units with lower performance and poor software (TRS-80 Model II) to higher performance, higher cost units (Perq). Where possible, a 64K dual disk system with display and keyboard (but no printer) is assumed.

RADIO SHACK TRS-80 MODEL II -- \$6,200

The Model II is a 64K, Z-80 based machine with dual 500KB floppy disks and a detachable keyboard. The hardware is acceptable and attractively priced. However, the system software is poor. Mediocre business accounting packages and word processing are available. The product will do well in the CP/M and COBOL markets due to the low price (XCP/M and COBOL are supported by the Z-80). However, the Model II will not be a significant factor in the office market because of its poor software and lack of additional features.

DATAPOINT 1500 -- \$6,600

Billed as a "dispersed data processor" for remote, single-user environments, the 1500 is a 64K system with dual 500KB floppy disks. Data entry, communications, and word processing software is available. Datapoint does not emphasize sales to small firms except through OEMs. The firm's major contribution is in large networks of shared resources (the "Integrated Electronic Office"). The IEO capabilities include DP, WP, communications, voice, and electronic mail. All resources in the network (i.e., File Processors and printers) can be shared. Datapoint will be a formidable competitor in the Fortune 1500 office market.

DEC DATASYSTEM 408 -- \$8,000

The advertised configuration of 32K with one 600KB floppy disk and matrix printer sells for \$8995 (The \$8,000 figure above estimates the cost of 64K with dual disks and no printer). DEC's very low end continues to be PDP-8 based systems with poor performance. Business accounting and WP software is available and is fair to good. DEC is an outstanding competitor and will probably obsolete this product with a similarly priced and higher performance unit based on the PDP-11 in 1981.

CPT 8000 -- \$8,990

The 8000 offers a full page black on white text display and two built-in 250KB floppy disks. Good to excellent WP software is available. The system is based on the Z-80 and supports CP/M (and with it COBOL, BASIC, etc.) through an option called CompuPak. CPT Corporation had sales of roughly \$55 million in 1979 and is well

positioned for rapid growth.

WANG WPS 5 MODEL I — \$10,000

The Model I is the low end of the Wang line and can be upgraded to any level of Wang Office Information System. The configuration consists of dual 250KB floppy disks and a Wang workstation. Good WP software is included. Expansion options include BASIC, WP Glossary (phrase storage), proportional space printing, global replace, and WP forms management. Network capabilities include a local coaxial cable net for up to four stations, electronic mail, shared hard disk, and an 18 page per minute Image Printer (i.e., intelligent copier). Wang is aggressive and well positioned and will be a formidable competitor in the office market.

IBM 5120 — \$11,500

The 5120 is essentially a repackaged 5110 and offers TRS-80 capabilities with an IBM logo (The primary difference is the greater disk storage offered— two floppy disks with a total of 2.4 Megabytes). The system is aimed at small business users and six accounting applications are offered for \$1440 each. IBM is a distinctive competitor but does not appear to be interested in competing on price. For this reason, the 5120 will probably expand the total market and not significantly dampen the sales opportunities of LISA.

CADO SYSTEM 20/IV — \$13,000

CADO's system does not match its advertised capabilities. The system supports up to four terminals has two 600KB floppy disks as standard, provides both WP and accounting packages, "multitasking", and offers a "natural language" data base query feature called "Just Ask". In actuality, some of the advertised packages are not available, and others are hardware and software "kluges". The word processing software is particularly difficult to use. CADO will continue to sell effectively in the low end of the multi-terminal small business market, but will not have any noticeable impact on the office market.

IBM 5520 — \$13,000

The 5520 is IBM's first electronic mail system. The minimum configuration has five workstations and a 128 Megabyte disk for \$65,000. Called the "Administrative System", the 5520 is primarily used for document creation and distribution. Also included are capabilities for form letters and document libraries. The electronic mail features will not be available until mid-1981. The 5520 will be a significant office product simply because it is IBM's. It will be particularly popular with IBM's large mainframe customers.

XEROX 860 — \$15,400

The 860 is similar to the 850 except that software is downloaded into

the machine (and is therefore easier to enhance), BASIC is offered, and a coaxial cable network ("Ethernet") is provided. Ethernet allows electronic mail and sharing of various peripherals including hard disks, printers, intelligent copiers, OCR, and photo composers. The 860 also offers a full page, black on white text display. Although Xerox is a significant competitor and is going in the right direction, it is believed that the 860 is an unreliable and expensive product at present.

PERQ — \$19,500

The expensive Perq comes closest to the spirit of LISA— and in many ways exceeds it! The system offers a bit-slice processor that has a 32-bit segmented virtual addressing mechanism and directly executes Pascal P-code (one million instructions per second), 256KB of main memory, and a 12 Megabyte hard disk. The display is totally bitmapped, black on white, with resolution of 768 x 1024. A touch tablet is provided for cursor positioning on the full page, 60 Hz refresh display. Up to 64 workstations can be interconnected on a single coaxial cable and packets can be broadcast at 10 million bits per second. The system supports async, bisync, SDLC and other protocols. No wonder Perq costs \$19,500!

FINIS

# A Guide for the Unwary The Six Laws of Micros

by Jim Edlin

- First Law: Micros are not computers.
- Second Law: Micros are like Veg-O-Matics.
- Third Law: Micros do not a Micro Age make.
- Fourth Law: The big business is not small business.
- Fifth Law: Micros will be commanded, not programmed.
- Sixth Law: Micros are geniuses (still bottled).

A watershed invention is knocking at our door, disguised as the microcomputer. Watershed inventions are those few-per-century developments such as the electric light, the telephone, the automobile, and television, which act as catalysts, producing drastic transformations in how we all live and work.

Bottled inside today's microcomputer is the product which promises to reach watershed status next.

These six laws and commentary represent one man's opinions about how the micro can fulfill its destiny as a watershed invention, and suggestions on how to take advantage of the impending Micro Age.

## I. Micros are not computers

Does that sound goofy? To say that micros, meaning microcomputers, are not computers? Then consider this statement: Cars are not trucks.

Think about that. Without straining, you can describe a car and a truck so they sound identical save for size. Both are powered by internal combustion engines, roll on wheels, burn fuel, are operated by drivers over roads, and have compartments for transporting people and cargo. But, everyone knows cars are not trucks, nor micro-trucks; and intuitively, everybody knows why.

The distinction between micros and computers is similar. Computers and micros may be technically identical—CPU's, memory, I/O, peripherals, programmability—just as cars and trucks are. But they are functionally different.

Consider a day in the life of an average Chevy, versus a day in the life

of a Peterbilt semi. The Peterbilt spends its day delivering case lots of dog food to a dozen supermarkets, and will do the same thing yesterday, and will do the same tomorrow. The Chevy delivers Mom to the supermarket to buy a few cans of that dog food. Earlier, it took Susie to ballet class; tonight, it will haul Junior and his date to the drive-in.

Consider the parallel situation of the ways in which micros can be used, as opposed to how computers are now used, and you should begin to grasp why micros are not computers.

In shrinking to a size and price which allow nearly everybody to have one, computers are undergoing a qualitative as well as quantitative change. Micros fit into a universe of personal uses which are trivial or impractical for conventional computers. Conceptually, this new class of uses cleaves micros away from computers as sharply as your mind separates the concepts of car and truck.

This, combined with the inevitable erosion from familiar use, is why even the word "computer" will probably disappear from the everyday name for microcomputers; folks will most likely come to call them simply "micros." To people in the not-so-distant Micro Age, the link between micro and micro-computer will be just as academic as the one between car and horseless carriage.

Some micro pioneers from the traditional computer world strongly resist the idea that micros are not computers. This is understandable. For years, these pioneers have been trying to convince their colleagues that micros really are computers, intending by that that computer pros should not consider micros beneath their notice. So, let it be clear that the First Law doesn't say micros are less than computers, only that they are different. In time, micros will probably prove far more significant than computers in our society.

The First Law's key message about micros: Forget about what makes them work; focus on what they can do.

## II. Micros are like Veg-O-Matics

Remember the commercials? "It slices, dices, chops, and peels. It can make two tons of coleslaw in less than a minute..." They had to promise you that whole rattled-off stream of uses just to sell you a ten-buck item.

Does that give you a clue about what it will take to convince folks to pop a four-figure sum for a good micro setup?

An alternate way of stating the Second Law is: People will buy uses, not micros. Televisions offer another helpful analogy.

People do not buy television sets. What they do buy is football games, soap operas, Saturday cartoons, and a big movie every now and then. The television set is merely the package those things come in. If the football games were the only broadcast fare, Dad might have trouble justifying the purchase of a nice color console. Similarly, asking what people will pay for a micro is asking the wrong question.

Ask instead what they will pay for entertainment, for information, for communication, for recordkeeping, for device control, for all the uses you can squeeze into the box. Then add up those psychological prices that's what you can sell a micro for, uses included.

It is important that the uses be included, by the way. While we are fooling with analogies, let's not get caught making one between micros and record players. Micros don't fit the "sell 'em the players then sell 'em the records" pattern. People already understand what value they get from a record player, and probably already own some records as well. Neither is likely to be true for micros at first.

Micros need to provide a critical level of usefulness right out of the box in order to justify purchase.

For coleslaw-haters, the Veg-O-Matic people showed fast apple slicing for pies, tearless onion chopping, and so on. The more they showed, the better their chance that a few appealing uses would add up to a sale for any given viewer. The same percentages on a bigger scale apply to micros.

An extra comprehension is that the perceived usefulness of a micro is likely, to a large extent, to depend on how many other micros are already out in the world. If early micros come across as useful enough to sell quickly, later ones will sell even faster. So, manufacturers should overcome their computer-bred instincts, and fearlessly throw in the word processor, the data base manager, the financial planning model, the information utility hook-up—all with the basic price of the box. Amortized over millions of units, giving those away becomes a trivial cost to clinch the sale. (Do you begin to see why micros aren't computers?)

Analogies always break down somewhere. There is one thing micros definitely do not have in common with Veg-O-Matics. Micros will not be used a few times, then stored on a closet shelf forever...unless the micro industry fails to heed the Third Law.

## III. Micros do not a Micro Age make

We return to cars as an analogy for the Third Law. Think of this as the Law of Autos and Highways.

Early auto manufacturers had a chicken-egg problem. People aren't eager to buy cars when there aren't many roads and few are eager to build roads when there aren't many people who own cars.

Obviously, it is in the interest of people who would own auto factories—or gas stations, muffler shops, tire factories and so on—for highways to be built. But, the building of highways is usually beyond the resources of those people. The micro industry faces a similar catch.

The Second Law says it takes uses to sell micros; the Third Law says the power to create the really appealing uses lies outside the micro industry. Putting it another way, the micro industry's destiny lies in other people's hands.

Please do not confuse uses with programs or software. Uses are value for money—the necessary ingredient for making a Micro Age. For most of their prime uses, micros will require interaction with things outside themselves, products manufactured by others, information owned by others, services provided by others, communications channels controlled by others.

All these "others," together with the government, are the ones who have power to build the metaphorical highways for micros.

To pave the way for the mass-market micro, you must make it profitable for them to do what is profitable for you.

For the micro industry, to promote uses is to promote sales. Before millions of micros can be sold, some very tough customers will have to be sold on supporting the industry's efforts. The immediate choice facing the micro industry is whether it will work together to lobby the building of straight, smooth highways or leave the highway-building to random happenstance and accept whatever tortuous, treacherous routes evolve.

The chicken-egg equation for micros is very clear: If the micro industry acts chicken about aggressive lobbying with publishers, retailers, communications companies, governments, financial institutions, and all the others who must act favorably, then micros are sure to lay an egg.

## IV. The big business is not small business

There is a current notion that the real bonanza for micros will be the "small business" market. This means little computers doing for little businesses the same things big computers do for big businesses: accounting, but keeping process control, etc. The general rule for that kind of work is "One business, one computer." (Occasionally, "One department, one computer.")

There certainly are a lot of small businesses, and money is there to be made selling them their one computer each, which they definitely can use. But, according to the First Law, that is

Jim Edlin is director of Micro-Marketing Consultants, a firm specializing in advising companies on the advent of the mass-market micro-computer. He is also co-author (with David Bunnell) of *MICRO: The Next Watershed Invention And How It Will Change Your Life*, a book to be published in 1980 from which the Six Laws are adapted.

not the real opportunity for micros. When micros go to work in businesses, they will approach a ratio of one person, one micro, just as the general rule now is one person, one telephone. And, the businesses they work in will be large, medium and small.

Micros are neither home computers nor small business computers. They are personal computers, capable of performing both duties.

To illustrate that point, ask yourself whether a telephone is a consumer product or a business product. The same instrument is used in both applications: it can be used for a business purpose one moment, a personal purpose the next. Much of its work is done in that middle ground between the two domains. Micros have the same qualities.

In business, micros will indeed be concerned with the accounting system, in their own fashion of personal service. But, they will also serve as intelligent scratchpads, video-shones, drawing boards, desk calendars, mailroom clerks, research assistants, filing cabinets, and on, and on, and on.

To keep your perspective about where the real opportunity lies, simply remember this: Small business applications mean one business, one computer. Micros mean one person, one computer even if nobody will ever call it a computer.

## V. Micros will be commanded, not programmed

Among people concerned with micros, there is a running debate over the likelihood that masses of people will ever be capable of—or interested in—programming computers.

Those who say "no" expect that all popular uses of micros will be limited to running canned programs. Those who say "yes" expect kids will one day study programming as they now study playing the piano. (The yes-sayers debate among themselves over which programming language the kids will be studying.)

Of course, the First Law tells us the debate is irrelevant to micros.

It is probably quite true that the average man and woman won't have the interest, patience, and logical turn of mind to do traditional programming in a conventional coded language. But, don't let that mislead you into believing the average owner won't want to command his micro.

One respect in which micros are like computers is that both are quintessentially general-purpose tools. People will surely want to use their micros' capabilities to do unique combinations of things packaged programs just won't provide for. The key distinction is between "program" and "command."

In both cases, the goal is a set of instructions which tells the micro and its peripherals what to do. To program, the user must know both where he wants to go, and how to get there;

however, to command, the user need only know where he wants to go (At a more sophisticated level, he will need to know only where he does not want to go.) His micro itself, with the help of an internal meta-program for programming, figures out how to reach the chosen destination.

Although such meta-programs do not yet exist in versions with broad enough scope, they are more than just wishful thinking. It can be done, as is proved by the first-generation efforts which are already up and running in the conventional computer world. What remains to do it better and more comprehensively. Creating programs to program is no small or inexpensive task, but a look at the history of telephony suggests why it will be done anyhow.

In the early days of the telephone, the economic way to connect callers was to use human operators. You couldn't cost-justify the invention and installation of machines to do the job. Today, the Bell System claims if all calls were still connected by operators, they would have to employ half the population of America at their switchboards. Geometric expansion of the market made switching machines an economic imperative.

When computers were numbered in tens of thousands, human programmers still made economic sense; when micros number in the tens of millions, programming machines will make just as much sense.

Combine that thought with another aspect of the car-truck analogy: Would-be truck drivers are willing to pay hefty sums, and spend weeks in school, to learn the intricacies of shifting a 15-speed transmission, jockeying a big rig in tight places, and so on. Then, they cope with these difficulties day-in-and-day-out because they are paid to do so. Imagine Chevrolet trying to convince its passenger car customers they should put up with such difficulties.

Micros will be commanded, not programmed. If that takes more power than a micro can provide on its own, it will be done through time-sharing with a megacomputer. But it will be done.

If that seems daunting, think how the telephone pioneers must have felt about stringing a wire to every home and business in America.

## VI. Micros are genies (still bottled)

A computer is operated by loading a program which it then proceeds to execute. Not micros. (First Law again.) Mass-market micros in both home and business will operate under the principle of "your wish is my command." Naturally, there will be programs controlling the micro's actions, but they will not be apparent as such to the users.

Do not think of micros following the computer's model of selecting a program for one job, loading it, and running it. For a minority—the micro equivalent of sports car owners who

enjoy shifting gears—that will be acceptable the rest of the world wants automatic transmissions, and it will also want micros that keep track of their own programming.

Think of each micro as having a master program which is always—always—running. The micro is never turned off. Think of this master program as a genie: it will seem like one to the micro's owner. The genie-program will keep a running inventory of all the capabilities available to the user, and guide him to invoke each as it is desired.

Should the micro need assistance from the user—loading of a tape, perhaps—to perform a chosen task, it will so request, and tell where the tape is stored. (Of course, one of a micro's basic routines will be one to inform it a new capability is being added to its repertoire.)

All a micro's capabilities will need to link to each other effortlessly and transparently. The address book should link to the phone dialer and letter writer, the phone dialer to the program that keeps track of telephone charges, which links to the program that receives, audits and pays bills, which links to the income tax program ad infinitum. And all will be accessible merely by answering the micro's question: "What is your wish now, O master?"

The reason the micro will become a watershed invention, and a mass-market item, is because everybody would like to have his or her own private genie. And the essence of that genie is contained within the micro. All we await is the uncorking of the bottle, the rubbing of the lamp.

## Epilogue: Red Herrings

During its short span of existence, one capability the micro has demonstrated to excess is the spawning of red herrings.

The first red herring was the hobby computer market. Although this was infinitesimally tiny in terms of the mass market, the companies which served it were also comparably tiny. So, even the tiny demand of the hobbyists was enough to suck those little companies dry of product, and thus suck other unwary companies into the market.

If you hope to prosper in the age of the micro, banish the notion of hobby computers from your mind forevermore.

Today's most damaging red herring is the small-business computer market. There is money to be made here, and it is more serious money than the hobby market offered. It will take real vision and fortitude not to be distracted by this one.

A third red herring is the evolution of videogames into home computers. The trap here is confusion between a home computer and a personal computer. A personal computer is a micro; a home computer is most likely just an overgrown game.

The nub of the matter is that micros make computer power practical for

individuals, which amounts to bringing a new invention into the world. Anyone tending to think of micros as computers brings along a whole arsenal of assumptions which could lead to bad decisions. These assumptions may include who should sell micros, how they should be sold, what they should be like, how much they should sell for, how the industry should behave, and even who comprises "the industry."

There are more red herrings to come. Perhaps the foregoing Laws will serve to insulate the ordinary from their lure.